

FAI6/BP-0E

cylindrical photosensors



Micro Detectors

Italian Sensors Technology



Indicative image

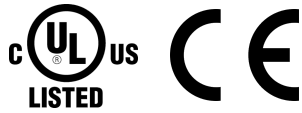
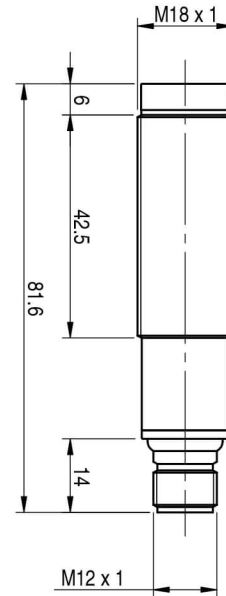

Detection properties

Nominal sensing distance	400mm white target 90% Kodak 200x200mm
Thermal drift of Sr	≤10% Sr
Repeat Accuracy	5%
Sensitivity adjustment	No

Application

Function Principle	Diffuse reflection (medium distance, ≤600mm)
Optic position	Axial

Outputs

Output type	PNP
Output Function	NO+NC
Switching frequency	250Hz

Electrical data

Operating Voltage	10...30Vdc
No-Load supply current	≤30mA
Load current	≤100mA
Leakage current	≤10μA

Output voltage drop	2V max. IL =100 mA
Max ripple content	10%
LED indicators	Yellow (Lon) or output status Lo/Do
Time delay before availability	≤200ms
Short-circuit protection	Short circuit (autoreset), Overvoltage
Reverse Polarity Protection	Polarity inversal, Impulsive voltage
Emission	Infrared (880 nm)
Interference to external light	3000lux (incandescent lamp), 10000lux (sunlight)

Mechanical data

Dimensions	M18 x 1 /L =81,6mm
Weight	30g
Housing Material	PBT / PC plug
Connections	M12 plug
Active Head Material	PC
Tightening torque	1Nm
Operating temperature	- 25°C...+ 70° C (Without freeze)
Diameter/Dimension	M18

Test/Approvals

Approvals	CE, cULus
EMC compatibility	EN 60947-5-2
Shocks and vibrations	Vibration IEC 60068-2-6 / Shock IEC 60068-2-27
Degree of protection	IP67

Accessories

Supplied Accessories	nuts M18 x 1
----------------------	--------------

ELECTRICAL DIAGRAMS OF THE CONNECTIONS

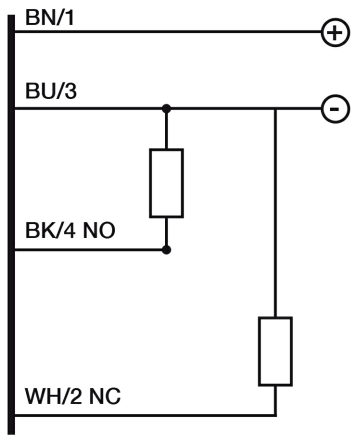

CONNECTOR

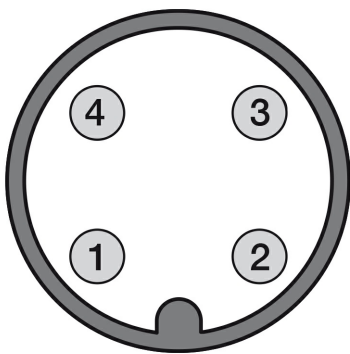

RESPONSE CURVES

Dimensione Spot

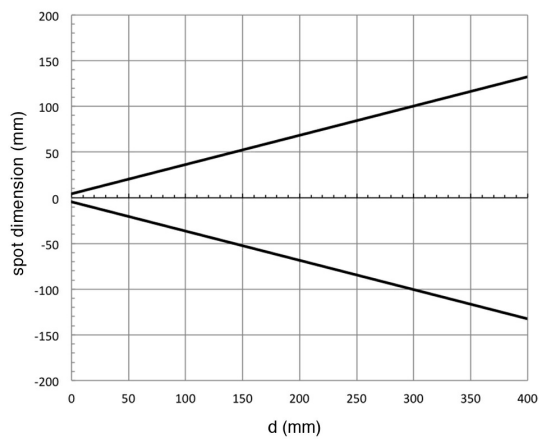

Disassamento Parallelo

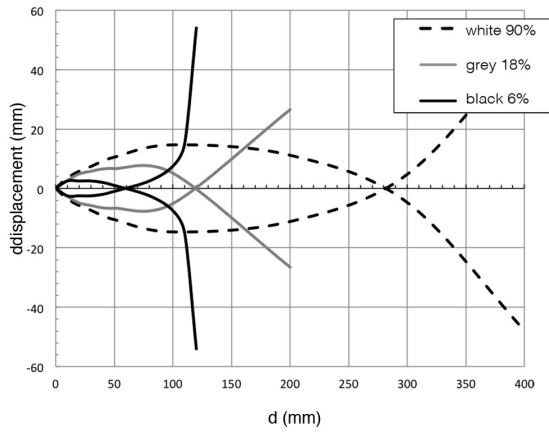

Eccesso di Guadagno

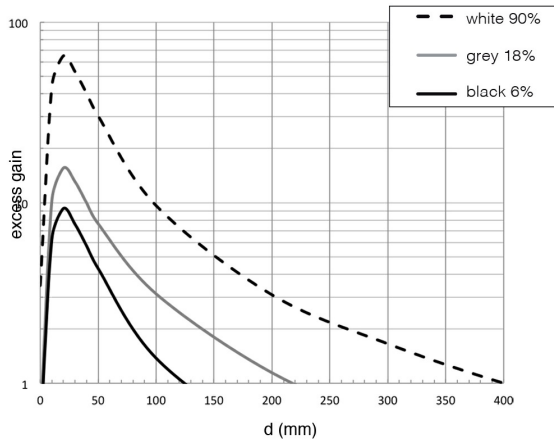

M.D. Micro Detectors S.p.A.

Strada S. Caterina, 235

41122 Modena (MO)

Tel. 059 420411

Fax 059 253973

E-mail info@microdetectors.com

date of printing

14/04/2020 16:32:14