

KGNW Series Control Stations

IP40 Enclosed Steel Control Stations Mounting of $\varnothing 22$ mm Switches and Pilot Lights with Space-Saving Design

The KGNW control stations are designed for mounting IDEC $\varnothing 22$ mm (7/8 inch) switches and pilot lights.

- Various standard control stations are available from one to four holes with most widely used combinations of switches and pilot lights (contact configurations, voltage, button colors, and nameplates).
- Enclosures only are also available, in which specifically selected TW series can be mounted as required.

Ideal for small control stations



KGNW Control Station with four $\varnothing 22$ mm switches/pilot lights

KGN Control Station with three $\varnothing 30$ mm switches/pilot lights

- HW series can also be installed.



Specifications

Degree of Protection	IP40 (IEC60529)
Material (Box)	Carbon steel plate (t=1.0 mm)
Coating Color (Melamine coating)	Yellow semi-gloss (Munsell 5Y7/1)
Rated Insulation Voltage	600V
Insulation Resistance	5 M Ω minimum
Dielectric Strength	Between live and dead parts: 2500V AC, 1 minute
Standard Operating Conditions	Ambient temperature: -25 to +50°C (no freezing) Relative humidity: 45 to 85% (no condensation)
Enclosure Style	Wall mount (1 holes)
Cable Lead-in (Wall Mount Model)	Double knockouts On top: $\varnothing 22$ and $\varnothing 27$ mm On bottom: $\varnothing 16$ and $\varnothing 20$ mm
Applicable Switches/Pilot Lights	IDEC $\varnothing 22$ mm TW/HW series

Switches/Pilot Lights Mounting Holes

The holes for mounting switches and pilot lights are 22.2 mm in diameter with an anti-rotation notch.

Mounting centers are 50 mm on 2- and 3-hole enclosures, and 36 mm on 4-hole enclosures.

Double Knockouts

The top and bottom surfaces have double knockouts.

On top: $\varnothing 22$ and $\varnothing 27$ mm double knockouts

On bottom: $\varnothing 16$ and $\varnothing 20$ mm double knockouts

One rubber bushing is supplied to protect lead-in wires from damage on the wire surface; 1- and 2-hole enclosures are supplied with a bushing to fit $\varnothing 20$ and $\varnothing 22$ mm holes, and 3- and 4-hole enclosures with a bushing to fit a $\varnothing 27$ mm hole.

Contact Ratings (Contact Block)

Contact Block	Rated Insulation Voltage	600V
	Rated Thermal Current	10A
	Contact Ratings by Utilization Category IEC60947-5-1	AC-15 (A600) DC-13

Operational Voltage and Current by Utilization Category

Operational Voltage		24V	48V	50V	110V	220V	440V	
Operational Current	AC (50/60Hz)	AC-12 Control of resistive loads and solid state loads	10A	—	10A	10A	6A	2A
	AC (50/60Hz)	AC-15 Control of electromagnetic loads (>72VA)	10A	—	7A	5A	3A	1A
Operational Current	DC	DC-12 Control of resistive loads and solid state loads	8A	4A	—	2.2A	1.1A	—
	DC	DC-13 Control of electromagnets	4A	2A	—	1.1A	0.6A	—

Common

Minimum applicable load (reference value) = 3V AC/DC, 5 mA (the applicable range is subject to change according to the operating conditions)

Rubber Bushing (Supplied) Color: Black

Enclosure Style	Supplied Bushing			Applicable Knockout Hole
	Part No.	Outside Dia.	Inside Dia.	
1 or 2 holes	GB-2	$\varnothing 30$ mm	$\varnothing 16$ mm	$\varnothing 20$ or $\varnothing 22$ mm
3 or 4 holes	GB-3	$\varnothing 38$ mm	$\varnothing 20$ mm	$\varnothing 27$ mm

$\varnothing 22/\varnothing 27$ mm Double Knockout



Switches/pilot lights

Cover Fastening Screws





Rubber Bushing

$\varnothing 16/\varnothing 20$ mm Double Knockout

Control Stations with Switches/Pilot Lights





























The control stations are available with selected combination of switches and pilot lights as listed below. For the dimensions and mounting centers, see the figures on page 7.





















Switches/Pilot Lights	Part No.	Specifications
Pushbutton 	ABW110 *	Flush, 1NO
	ABW101 *	Flush, 1NC
	ABW111 *	Flush, 1NO-1NC
	ABW411 *	ø40 mushroom, 1NO-1NC
Pilot Light 	APW116D *	Round flush, 100/110V AC
	APW126D *	Round flush, 200/220V AC
Selector Switch 	ASW211	Knob, 2-position, 1NO-1NC
	ASW320	Knob, 3-position, 2NO
	ASW2K11	Key, 2-position, 1NO-1NC

Note: Specify a button or lens color code in place of *:
 Pushbutton: B (black), G (green), R (red)
 Pilot Light: G (green), R (red), W (white)

Control Stations

Package Quantity: 1

Control Station		Mounted Switches/Pilot Lights		
Style	Part No.	Symbol	Part No.	NWA Nameplate Legend
Wall Mount 1 hole	KGNW1101Y		ABW110B	ON
	KGNW1102Y		ABW411R	Without nameplate
	KGNW1103Y		APW116DR	Without nameplate
	KGNW1104Y		APW126DR	Without nameplate
	KGNW1105Y		ASW211	HAND-AUTO
	KGNW1106Y		ASW320	HAND-OFF-AUTO
	KGNW1107Y		ASW2K11	OFF-ON
Wall Mount 2 holes	KGNW2101Y	 	ABW110B ABW101R	ON OFF
	KGNW2102Y	 	ABW111B ABW111R	ON OFF
	KGNW2103Y	 	APW116DR APW116DG	Without nameplate
	KGNW2104Y	 	APW126DR APW126DG	Without nameplate
	KGNW2105Y	 	APW116DR ABW111R	Without nameplate STOP
	KGNW2106Y	 	APW126DR ABW111DR	Without nameplate STOP
	KGNW2107Y	 	APW116DR ASW211	Without nameplate HAND-AUTO
	KGNW2108Y	 	APW126DR ASW211	Without nameplate HAND-AUTO
	KGNW2109Y	 	APW116DR ASW2K11	Without nameplate OFF-ON
	KGNW2110Y	 	APW126DR ASW2K11	Without nameplate OFF-ON
	KGNW2113Y	 	ABW110B ABW411R	ON Without nameplate

Control Station		Mounted Switches/Pilot Lights		
Style	Part No.	Symbol	Part No.	NWA Nameplate Legend
Wall Mount 3 holes	KGNW3102Y	  	APW116DR ABW110B ABW101R	Without nameplate ON OFF
	KGNW3103Y	  	APW126DR ABW110B ABW101R	Without nameplate ON OFF
	KGNW3104Y	  	ABW111B ABW111R ASW211	ON OFF HAND-AUTO
	KGNW3105Y	  	APW116DW APW116DR APW116DG	Without nameplate
Wall Mount 4 holes	KGNW4101Y	   	APW126DR APW126DG ABW111B ABW111R	Without nameplate Without nameplate ON OFF
	KGNW4102Y	   	APW126DR ABW111B ABW111R ASW211	Without nameplate ON OFF HAND-AUTO

Empty Enclosures

Package Quantity: 1

Style	Part No.	Unit Mounting Hole	Switches/Pilot Lights Mounting Centers
1 hole (approx. 0.4 kg)	KGNW111Y	With	
	KGN110Y	Without	
2 holes (approx. 0.5 kg)	KGNW212Y	With	
	KGN210Y	Without	
3 holes (approx. 0.6 kg)	KGNW313Y	With	
	KGN310Y	Without	
4 holes (approx. 0.6g)	KGNW314Y	With	
4 holes (approx. 0.7 kg)	KGNW414Y	With	
	KGN410Y	Without	
5 holes (approx. 0.8 kg)	KGNW515Y	With	
	KGN510Y	Without	
Switches/Pilot Lights Mounting Hole		Effective Depth inside the Enclosure	
All dimension in mm			

Accessories

Package Quantity: 1

Name	Part No.	Applicable Enclosure	Applicable Knockout Hole
Rubber Bushing	GB-2	KGNW111Y	ø20 or ø22 mm
		KGN110Y	
		KGNW212Y	
		KGN210Y	
	GB-3	KGNW313Y	ø27 mm
		KGN310Y	
		KGNW314Y	
		KGNW414Y	
		KGN410Y	
		KGNW515Y	
KGN510Y			

Dimensions

All dimensions in mm.

KGNW

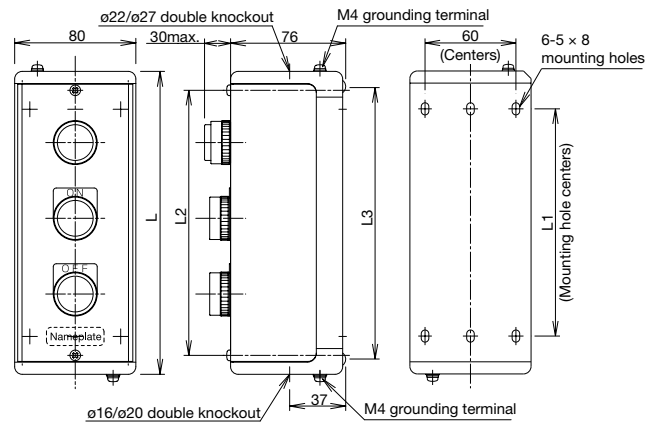

	1 hole	2 holes	3 holes	4 holes		5 holes
	111Y	212Y	313Y	314Y	414Y	510Y
L	100	150	200	200	250	300
L1	50	100	150	150	200	250
L2	75	125	175	175	225	275
L3	80	130	180	180	230	280
Weight (Approx.)	0.4 kg	0.5 kg	0.6 kg	0.6 kg	0.7 kg	0.8 kg

Instructions

Precautions for Opening the Knockout Hole

- The metal piece for the inner hole of ø22 or ø16 mm knockout has two linked parts to the outer hole. When breaking the knockout to make an inner hole, strike the inner metal piece at the cut parts (the hatched parts shown as point A at right) using a screwdriver tip or similar tool.
- When opening a larger hole of ø27 or ø20 mm, first make a smaller hole as described above. Then break the knockout for the larger hole using pliers.

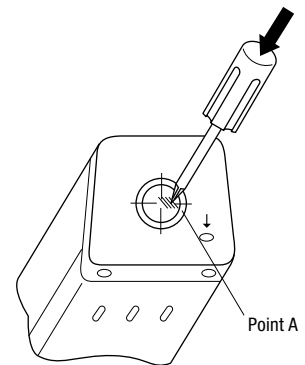

Ordering Information

When ordering control stations with switches/pilot lights:
Specify the Part No. of the control station.

When ordering enclosures without switches/Pilot lights:
Specify the following items.

- Part No. of the enclosure
- Part No. and specifications of the switches/pilot lights to be mounted (lens color, button color, etc.)
- Nameplate
- Other specifications

Ordering Example

① ② ③	Part No. of Enclosure		KGNW313Y
	Switches/Pilot Lights and Nameplate	①	APW126DR
		②	ABW210G, with NWA-1
	③	ABW201R, with NWA-2	

Note: Any ø22 mm TW series are selectable. Take the effective depth inside the enclosure into consideration.