

Think Automation and beyond...

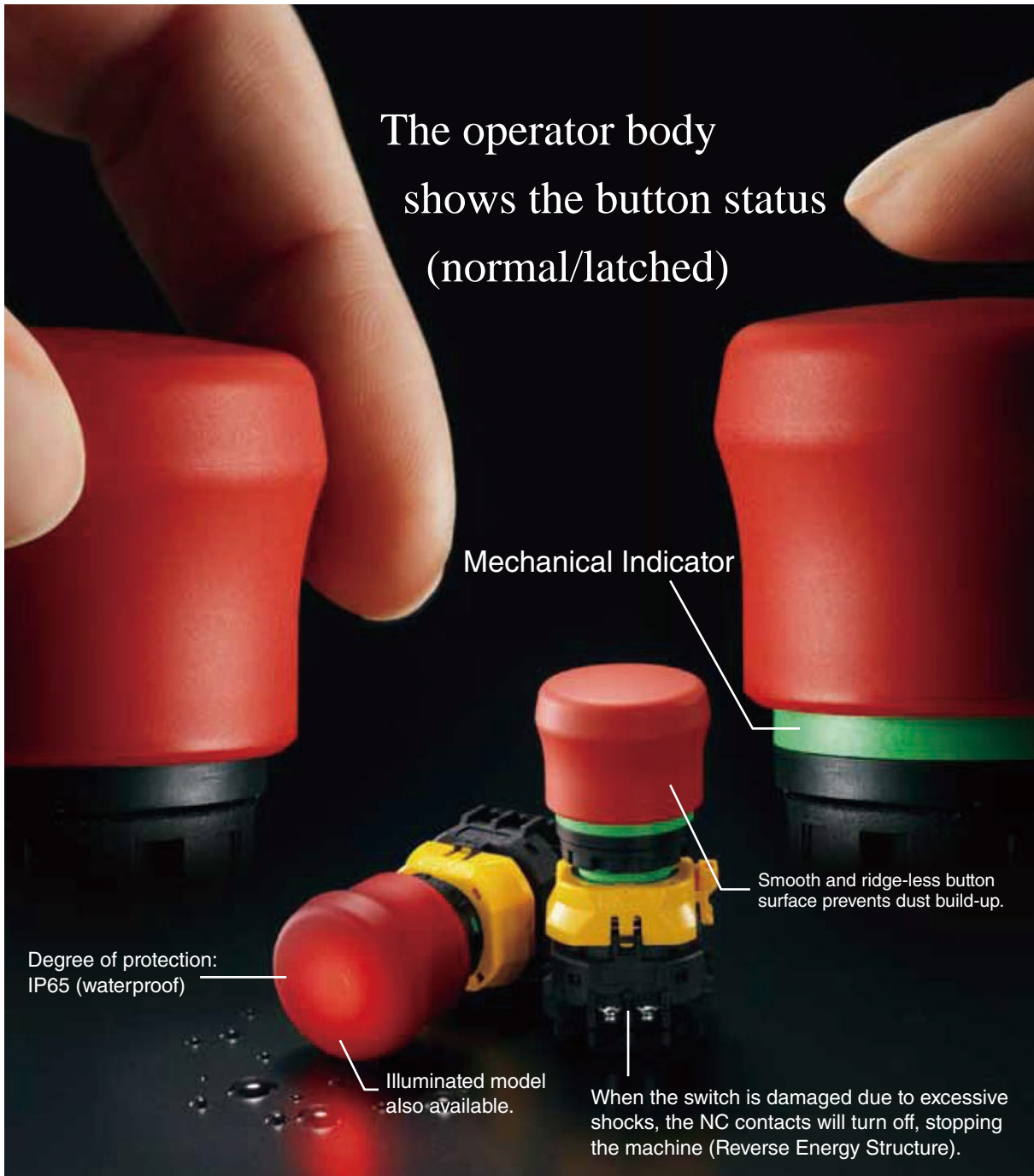

Ø22mm XW Series Emergency Stop Switches (Mechanical Indicator)

Normal/latched status can be checked from a distance with the mechanical indicator function.
The smooth ridge-less button prevents dust build-up and assures comfortable operation.



IDEC CORPORATION

XW Series

(Actual Size)

Excellent safety mechanisms including a mechanical indicator that shows contact status.

Non-illuminated

Illuminated



The smooth and ridge-free button surface prevents dust build-up, and is also easy to clean. Ideal for applications such as food processing machines.

IDEAC's sleek, smooth design reduces operator's stress and fatigue.

The safety mechanism ensures the XW contacts open (safe) even when damaged by excessive shocks (reverse energy structure, safe break action).

Mechanical Indicator – the operator body of the switch is green when the contacts are closed, the green is hidden when the switch is actuated.

NC contacts ON (button not pressed)

NC contacts OFF (button latched)

Safety for operators, machines and systems

Reverse Energy Structure

With XW series emergency stop switches, the potential energy level of the latched status is lower than that of the normal status. When the switch is damaged due to excessive shocks, the NC contacts will turn off, thus stopping the machine (patented design).

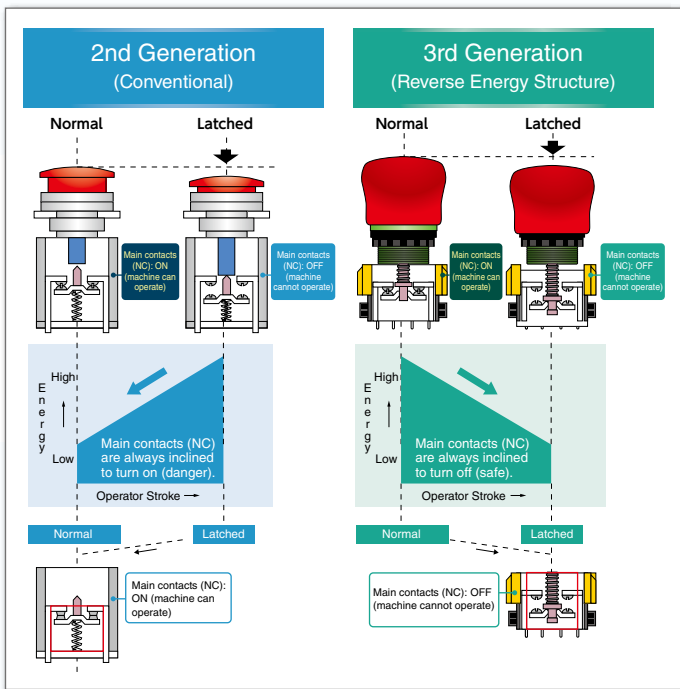

Resetting

XW series can be reset easily either by pulling or turning.



Safe Break Action

When the contact block is detached from the operator, the NC contact opens (OFF).

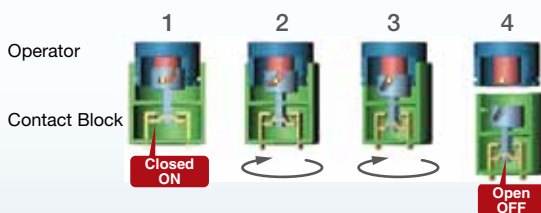

When the contact block is detached from the operator, the cam directly opens the NC main contacts (contacts are off).

Complies with International Standards

Safety Lock Mechanism

The emergency stop signal shall be maintained until the emergency stop device is reset (disengaged). (IEC 60947-5-5; 6.2)

Complies to international safety standards



Direct Opening Action

All normally closed contact elements of an emergency stop devices shall have a direct opening action (positive opening action), according to annex K of IEC 60947-5-1. (IEC 60947-5-5; 5.2)

ø22 XW Series Emergency Stop Switches (Mechanical Indicator)

High level of safety with Safe Break Action. Mechanical indicator on the operator body shows the contact status - green when NC contacts are closed - reducing the maintenance work.

- IDEC's original "Safe Break Action" and "Reverse Energy Structure" ensure the safety of operator and system, when the switch is damaged due to excessive shocks.
- The mechanical indicator on the operator body shows the normal/latched status (green: normal). Reduces maintenance work and improves operation efficiency.
- Illuminated model also available (same size as non-illuminated)
- The depth behind the panel is only 46.4 mm (w/terminal cover).
- 1 to 4NC main contacts and 1 or 2NO monitor contact
- Push-to-lock, Pull or Turn-to-reset operator
- Direct opening action mechanism (IEC 60947-5-5, 5.2, IEC 60947-5-1, Annex K)
- Safety lock mechanism (IEC 60947-5-5, 6.2)
- Degree of protection: IP65 (IEC 60529)
- Durable gold-plated contacts
- Finger-safe structure (IP20)
- UL, c-UL listed. EN compliant.
- UL NISD category



Standards

Applicable Standards	Mark	File No. or Organization
UL508 CSA C22.2 No. 14		UL/c-UL Listing File No. E68961
IEC60947-5-5 UL991 NFPA79 EN418		UL Listing File No. E305148
EN60947-5-1 EN60947-5-5 (Note)	 	TÜV SÜD EU low voltage directive
GB14048.5		CCC No. 2012010305589649

Contact Ratings (NC main contacts/NO monitor contact)

Rated Insulation Voltage (Ui)		Screw Terminal		250V			
Rated Thermal Current (Ith)		5A					
Rated Operating Voltage (Ue)		30V	125V	250V			
Rated Operating Current	Main Contacts	AC 50/60 Hz	Resistive Load (AC-12)	-	5A	3A	
			Inductive Load (AC-15)	-	3A	1.5A	
		DC	Resistive Load (DC-12)	2A	0.4A	0.2A	
			Inductive Load (DC-13)	1A	0.22A	0.1A	
Monitor Contacts	AC 50/60 Hz	Resistive Load (AC-12)	-	1.2A	0.6A		
		Inductive Load (AC-14)	-	0.6A	0.3A		
	DC	Resistive Load (DC-12)	2A	0.4A	0.2A		
		Inductive Load (DC-13)	1A	0.22A	0.1A		

- Minimum applicable load: 5V AC/DC, 1 mA (reference value) (Operating area depends on the operating conditions and load types.)
- The rated operating currents are measured at resistive/inductive load types specified in JIS C8201-5-1.

Illumination Ratings

Rated Voltage	Operating Voltage	Rated Current
24V AC/DC	24V AC/DC ±10%	15 mA

Note: An LED lamp is built into the contact block and cannot be replaced.

Specifications



Applicable Standards	IEC60947-5-5, EN60947-5-5 JIS C8201-5-1, UL508, UL991, NFPA79, CSA C22.2 No. 14, GB14048.5
Operating Temperature	Non-illuminated: -25 to +60°C (no freezing) LED illuminated: -25 to +55°C (no freezing)
Storage Temperature	-45 to +80°C (no freezing)
Operating Humidity	45 to 85% RH (no condensation)
Operating Force	Push to lock: 32N Pull to reset: 21N Turn to reset: 0.27 N·m
Minimum Force Required for Direct Opening Action	80N
Minimum Operator Stroke Required for Direct Opening Action	4.0 mm
Maximum Operator Stroke	4.5 mm
Contact Resistance	50 mΩ maximum (initial value)
Insulation Resistance	100 MΩ minimum (500V DC megger)
Overvoltage Category	II
Impulse Withstand Voltage	2.5 kV
Pollution Degree	3
Operation Frequency	900 operations/hour
Shock Resistance	Operating extremes: 150 m/s ² Damage limits: 1000 m/s ²
Vibration Resistance	Operating extremes: 10 to 500 Hz, amplitude 0.35 mm, acceleration 50 m/s ² Damage limits: 10 to 500 Hz, amplitude 0.35 mm, acceleration 50 m/s ²
Mechanical Life	250,000 operations minimum
Electrical Life	100,000 operations minimum 250,000 operations minimum (24V AC/DC, 100 mA)
Degree of Protection	Panel front: IP65 (IEC 60529) Terminal Protection: IP20 (screw terminal, when using XW9Z-VL2MF)
Short-circuit Protection	250V/10A fuse (Type aM, IEC60269-1/IEC60269-2)
Conditional Short-circuit Current	1000A
Terminal Style	M3 screw terminal
Recommended Tightening Torque for Locking Ring	2.0 N·m
Connectable Wire	0.75 to 1.25 mm ² (AWG18 to 16)
Recommended Tightening Torque for Terminal Screw	0.6 to 1.0 N·m

ø22 XW Series Emergency Stop Switches (w/Mechanical Indicator)

Mechanical Indicator Model

Non-illuminated Pushlock Pull/Turn Reset (Screw Terminal)



Package quantity: 1

Shape	NC Main Contact	NO Monitor Contact	Part No.		Button Color Code
			IP20	w/Terminal Cover	
 ø38 mushroom with mechanical indicator 	1NC	—	XW1E-BV4TG01MFR	XW1E-BV4TG01MR	R (red)
	2NC	—	XW1E-BV4TG02MFR	XW1E-BV4TG02MR	
	3NC	—	XW1E-BV4TG03MFR	XW1E-BV4TG03MR	
	4NC	—	XW1E-BV4TG04MFR	XW1E-BV4TG04MR	
	1NC	1NO	XW1E-BV4TG11MFR	XW1E-BV4TG11MR	
	2NC	1NO	XW1E-BV4TG12MFR	XW1E-BV4TG12MR	
	3NC	1NO	XW1E-BV4TG13MFR	XW1E-BV4TG13MR	
	2NC	2NO	XW1E-BV4TG22MFR	XW1E-BV4TG22MR	

- Pushlock pull/turn reset switches are locked when pressed, and reset when pulled or turned clockwise.
- IP20 types can be connected to solid wires only.

Illuminated Pushlock Pull/Turn Reset (Screw Terminal)

Package quantity: 1

Shape	Illumination	Rated Voltage	NC Main Contact	NO Monitor Contact	Part No.		Button Color Code
					IP20	w/Terminal Cover	
 ø38 mushroom with mechanical indicator 	LED	24V AC/DC	1NC	—	XW1E-LV4TG01Q4MFR	XW1E-LV4TG01Q4MR	R (red)
			2NC	—	XW1E-LV4TG02Q4MFR	XW1E-LV4TG02Q4MR	
			3NC	—	XW1E-LV4TG03Q4MFR	XW1E-LV4TG03Q4MR	
			4NC	—	XW1E-LV4TG04Q4MFR	XW1E-LV4TG04Q4MR	
			1NC	1NO	XW1E-LV4TG11Q4MFR	XW1E-LV4TG11Q4MR	
			2NC	1NO	XW1E-LV4TG12Q4MFR	XW1E-LV4TG12Q4MR	
			3NC	1NO	XW1E-LV4TG13Q4MFR	XW1E-LV4TG13Q4MR	
			2NC	2NO	XW1E-LV4TG22Q4MFR	XW1E-LV4TG22Q4MR	

- Pushlock pull/turn reset switches are locked when pressed, and reset when pulled or turned clockwise.
- IP20 types can be connected to solid wires only.
- LED lamp is not removable.

Dimensions

Screw Terminal (IP20)

Screw Terminal (w/terminal cover)

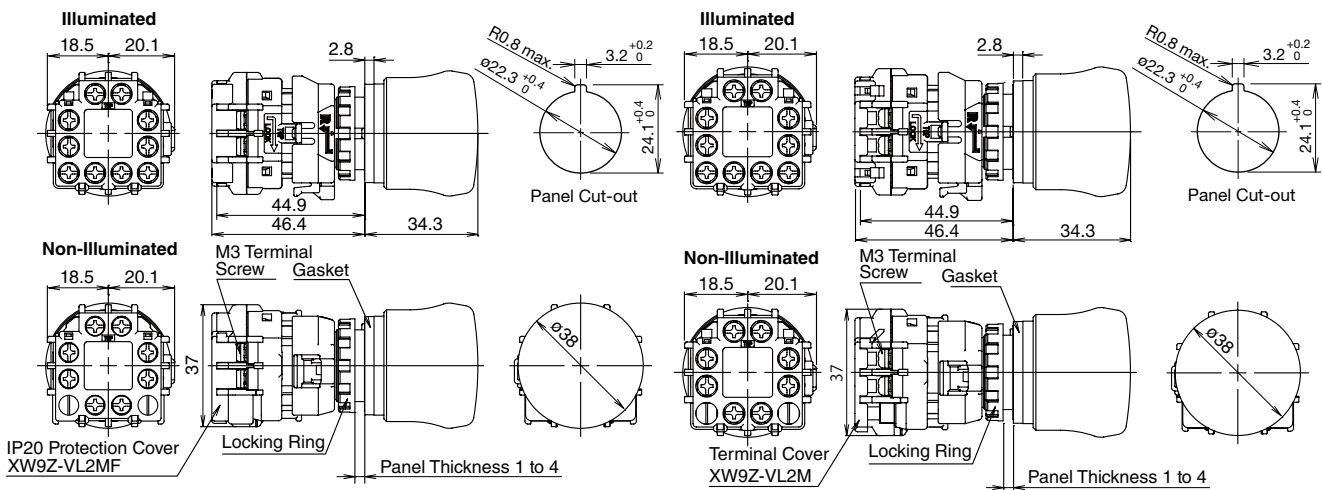

All dimensions in mm.

XW Series Emergency Stop Switches (w/Mechanical Indicator) ø22

Mounting Hole Layout

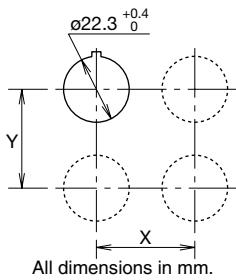

	X	Y
Screw Terminal	70 mm minimum	

• The values shown above are the minimum dimensions for mounting with other ø22mm emergency stop switches. For other emergency stop switches of different sizes and styles, determine the values according to the dimensions, operation, and wiring convenience.

LED Internal Circuit

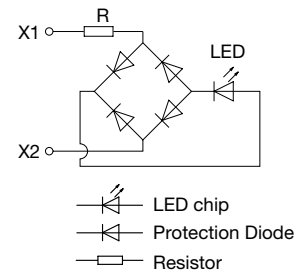

Terminal Arrangement (Bottom View)

Screw Terminal Non-illuminated

NC main contacts only
NC main contacts:
Terminals 1-2

With 1NO monitor contacts
NC main contacts:
Terminals 1-2
NO monitor contacts:
Terminals 3-4

With 2NO monitor contacts
NC main contacts:
Terminals 1-2
NO monitor contacts:
Terminals 3-4

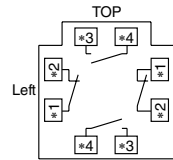
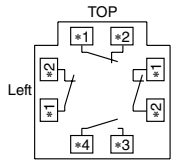
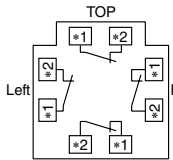

1NC: Terminals on right
2NC: Terminals on right and left
3NC: Terminals on right, left, and top

1NC: Terminals on top
2NC: Terminals on right and left

Screw Terminal Illuminated

NC main contacts only
NC main contacts:
Terminals 1-2

With 1NO monitor contacts
NC main contacts:
Terminals 1-2
NO monitor contacts:
Terminals 3-4

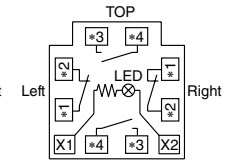
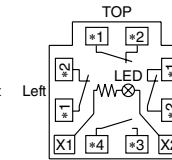
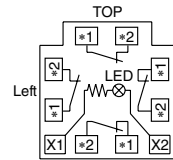

With 2NO monitor contacts
NC main contacts:
Terminals 1-2
NO monitor contacts:
Terminals 3-4



1NC: Terminals on right
2NC: Terminals on right and left
3NC: Terminals on right, left, and top

1NC: Terminals on top
2NC: Terminals on right and left

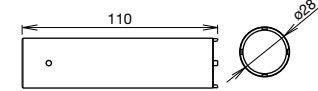
Accessories

Description & Shape	Material	Part No.	Ordering No.	Package Quantity	Remarks
	Metal (nickel-plated brass) (weight: approx. 150g)	MW9Z-T1	MW9Z-T1	1	<ul style="list-style-type: none"> Used to tighten the locking ring when installing the XW emergency stop switch onto a panel. 
	PPE	XW9Z-VL2M	XW9Z-VL2MPN02	2	<ul style="list-style-type: none"> Black Used for screw terminals. Attached to IP20 protection cover units.
	Polyamide	XW9Z-VL2MF	XW9Z-VL2MFPN02	2	<ul style="list-style-type: none"> Black Used on terminals for IP20 finger protection. Only solid wires can be used. The IP20 protection cover cannot be removed once installed.

• Screw terminal model has a terminal cover or IP20 protection cover.

ø22 XW Series Emergency Stop Switches (w/Mechanical Indicator)

Nameplate (for ø22 Emergency Stop Switches)

Description	Legend	Part No.	Ordering No.	Package Quantity	Material	Plate Color	Legend Color
For ø38/40mm Button	(blank)	HWAV-0-Y	HWAV-0-Y	1	Polyamide	Yellow	—
	EMERGENCY STOP	HWAV-27-Y	HWAV-27-Y				Black
	EMERGENCY OFF	HWAV-74-Y	HWAV-74-Y				

Maintenance Parts

Description & Shape	Material	Part No.	Ordering No.	Package Quantity	Remarks
 Locking Ring	Polyamide	CW9Z-LN	CW9Z-LNPN05	5	<ul style="list-style-type: none"> Black ø27.8, t = 5.0

Dimensions

Nameplate for ø38/40 Button

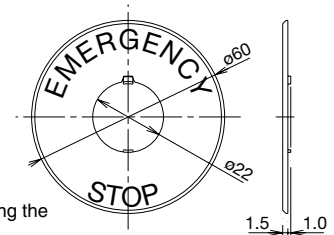

All dimensions in mm.

Safety Precautions

- Turn off power to the XW series emergency stop switch before starting installation, removal, wiring, maintenance, and inspection of the relays. Failure to turn power off may cause electrical shock or fire hazard.
- For wiring, use wires of the proper size to meet the voltage and current requirements. Tighten the M3 terminal screw to a tightening torque of 0.6 to 1.0 N·m. Failure to tighten the terminal screws may cause overheating and fire.

Instructions

Removing the Contact Block

First unlock the operator button. Grab the bayonet ring ① and pull back the bayonet ring until the latch pin clicks ②, then turn the contact block counterclockwise and pull out ③.

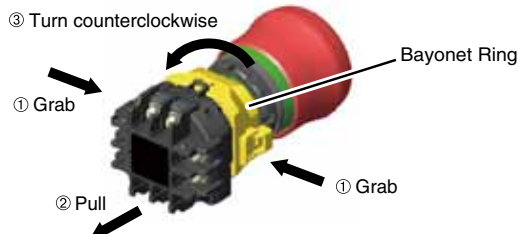

Notes for removing the contact block

- When the contact block is removed, the monitor contact (NO contact) is closed.
- While removing the contact block, do not exert excessive force, otherwise the switch may be damaged.
- An LED lamp is built into the contact block for illuminated pushbuttons. When removing the contact block, pull the contact block straight to prevent damage to the LED lamp. If excessive force is exerted, the LED lamp may be damaged and fail to light.

Panel Mounting

Remove the locking ring from the operator. Insert the operator from panel front into the panel hole. Face the side without thread on the operator with TOP marking upward, and tighten the locking ring using ring wrench MW9Z-T1 to a torque of 2.0 N·m maximum.

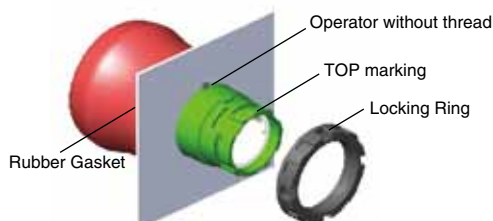

Installing the Contact Block

First unlock the operator button. Align the small ▼ marking on the edge of the operator with the small ▲ marking on the yellow bayonet ring. Hold the contact block, not the bayonet ring. Press the contact block onto the operator and turn the contact block clockwise until the bayonet ring clicks.

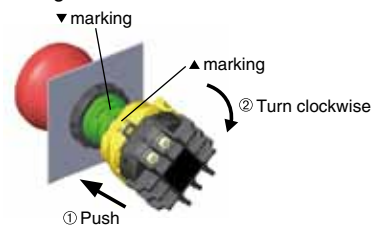

Notes for installing the contact block

Make sure that the bayonet ring is in the locked position. Check that the two projections on the bayonet ring are securely in place.

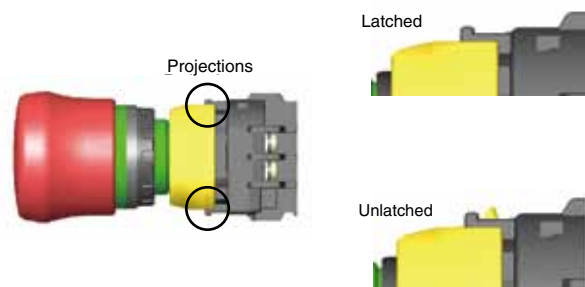

XW Series Emergency Stop Switches (w/Mechanical Indicator) ø22

Instructions

Wiring

1. Wire thickness: 0.75 to 1.25 mm² (AWG18 to 16)

Applicable Crimping Terminals

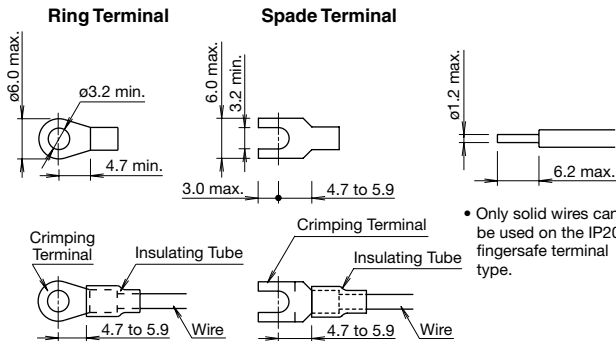

Solid Wire

• Only solid wires can be used on the IP20 fingersafe terminal type.

- Be sure to install an insulating tube on the crimping terminal.
- 2. Tighten the M3 terminal screw to a tightening torque of 0.6 to 1.0 N·m.

Installing & Removing Terminal Covers

XW9Z-VL2M

To install the terminal cover, align the TOP marking on the terminal cover with the TOP marking on the contact block. Place the two projections on the bottom side of the contact block into the slots in the terminal cover. Press the terminal cover toward the contact block.

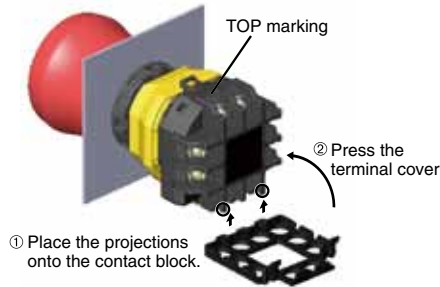

To remove the terminal cover, pull out the two latches on the top side of the terminal cover. Do not exert excessive force to the latches, otherwise the latches may break.

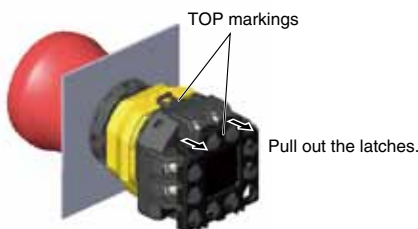

IP20 Protection Terminal Cover XW9Z-VL2MF

To install the IP20 protection cover, align the TOP marking on the cover with the TOP marking on the contact block, and press the cover toward the contact block.

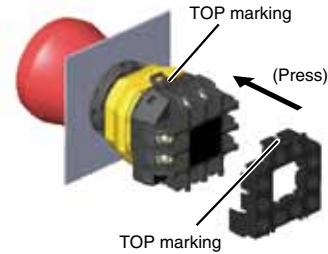

Notes:

1. Once installed, the XW9Z-VL2MF cannot be removed.
2. The XW9Z-VL2MF cannot be installed after wiring.
3. With the XW9Z-VL2MF installed, crimping terminals cannot be used. Use solid wires.
4. Make sure that the XW9Z-VL2MF is securely installed. IP20 cannot be achieved when installed loosely, and electric shocks may occur.

Contact Bounce

When the button is reset by pulling or turning, the NC main contacts will bounce. When pressing the button, the NO monitor contacts will bounce.

When designing a control circuit, take the contact bounce time into consideration (reference value: 20 ms).

LED Illuminated Switches

An LED lamp is built into the contact block and cannot be replaced.

Nameplate

When anti-rotation is not required, remove the projection from the nameplate or switch guard using pliers.

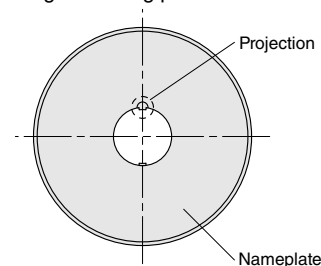

Handling

Do not expose the switch to excessive shocks and vibrations, otherwise the switch may be deformed or damaged, causing malfunction or operation failure.

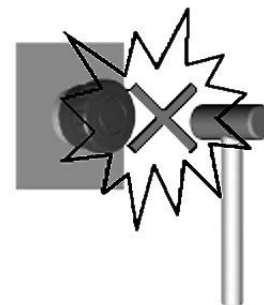

Specifications and other descriptions in this catalog are subject to change without notice.



IDEC CORPORATION

6-64, Nishi-Miyahara 2-Chome, Yodogawa-ku, Osaka 532-0004, Japan
Tel: +81-6-6398-2571, Fax: +81-6-6392-9731
E-mail: marketing@idec.co.jp

IDEC CORPORATION (USA)

1175 Elko Drive
Sunnyvale, CA 94089-2209, USA
Tel: +1-408-747-0550 / (800) 262-IDEC (4332)
Fax: +1-408-744-9055 / (800) 635-6246
E-mail: opencontact@idec.com

IDEC CANADA LIMITED

3155 Pepper Mill Court, Unit 4
Mississauga, Ontario, L5L 4X7, Canada

Tel: +1-905-890-8561
Toll Free: (800) 262-IDEC (4332)
Fax: +1-905-890-8562
E-mail: sales@ca.idec.com

IDEC AUSTRALIA PTY. LTD.

Unit 17, 104 Ferntree Gully Road,
Oakleigh, Victoria 3166, Australia
Tel: +61-3-8523-5900, Toll Free: 1800-68-4332
Fax: +61-3-8523-5999
E-mail: sales@au.idec.com

IDEC ELECTRONICS LIMITED

Unit 2, Beechwood, Chineham Business Park,
Basingstoke, Hampshire RG24 8WA, UK
Tel: +44-1256-321000, Fax: +44-1256-327755
E-mail: sales@uk.idec.com

IDEC ELEKTROTECHNIK GmbH

Wendenstrasse 331, 20537 Hamburg, Germany
Tel: +49-40-25 30 54 - 0, Fax: +49-40-25 30 54 - 24
E-mail: service@idec.de

IDEC (SHANGHAI) CORPORATION

Room 701-702 Chong Hing Finance Center,
No. 288 Nanjing Road West, Shanghai 200003, PRC
Tel: +86-21-6135-1515
Fax: +86-21-6135-6225 / +86-21-6135-6226
E-mail: idec@cn.idec.com

IDEC (BEIJING) CORPORATION

Room 211B, Tower B, The Grand Pacific Building,
8A Guanghua Road, Chaoyang District,
Beijing 100026, PRC
Tel: +86-10-6581-6131, Fax: +86-10-6581-5119

IDEC (SHENZHEN) CORPORATION

Unit AB-3B2, Tian Xiang Building, Tian'an Cyber Park,
Fu Tian District, Shenzhen, Guang Dong 518040, PRC
Tel: +86-755-8356-2977, Fax: +86-755-8356-2944

IDEC IZUMI (H.K.) CO., LTD.

Units 11-15, Level 27, Tower 1,
Millennium City 1, 388 Kwun Tong Road,
Kwun Tong, Kowloon, Hong Kong
Tel: +852-2803-8989, Fax: +852-2565-0171
E-mail: info@hk.idec.com

IDEC TAIWAN CORPORATION

8F-1, No. 79, Hsin Tai Wu Road, Sec. 1,
Hsi-Chih District, 22101 New Taipei City, Taiwan
Tel: +886-2-2698-3929, Fax: +886-2-2698-3931
E-mail: service@tw.idec.com

IDEC IZUMI ASIA PTE. LTD.

No. 31, Tannery Lane #05-01,
HB Centre 2, Singapore 347788
Tel: +65-6746-1155, Fax: +65-6844-5995
E-mail: info@sg.idec.com