

CF/RB9-10

optical fibers



Micro Detectors

Italian Sensors Technology



Indicative image

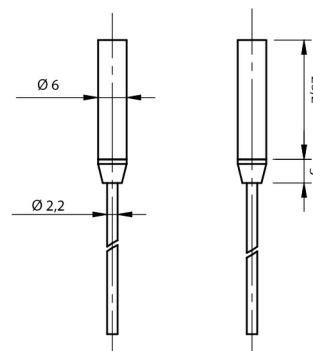

Detection properties

Distance with SSF	1.200 mm
Distance with FS1	1.200 mm
Distance with FX3	8.000 mm
Distance with FX4	10.000 mm
Distance with F1R	4.000 mm

Application

Function Principle Through-beam P/R

Description Plastic optical fibres

Mechanical data

Operating temperature -40°C....+70°C (posa fissa)

1 1

1 mm 1 mm

M4 con sleeve Ø 6 with lenti

vetro, ETM, inox PE, plastic

ottone nichelato nickel-plated brass

Test/Approvals

M.D. Micro Detectors S.p.A.

Strada S. Caterina, 235
41122 Modena (MO)
Tel. 059 420411
Fax 059 253973
E-mail info@microdetectors.com

date of printing

06/05/2020 15:00:26