

AM1/BP-3H

cylindrical inductive



Micro Detectors

Italian Sensors Technology

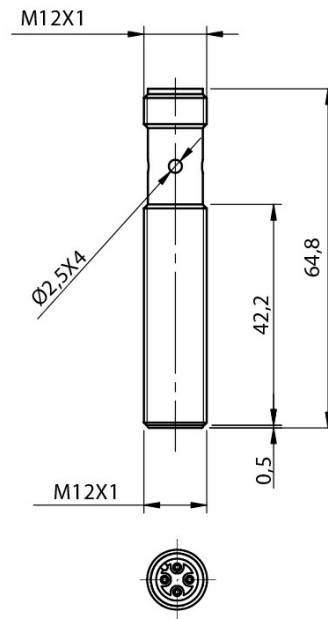

Detection properties

Nominal sensing distance	4mm
Operating distance	0...3,2mm
Standard target	12x12mm FE360
Correction Factor	copper: 0,33 / aluminum: 0,4 / brass: 0,5 / stainless steel: 1,05
Thermal drift of Sr	< 10%
Repeat Accuracy	5% (UB 24V Ta=23°C ±5°C)
Hysteresis	1 ... 20%

Outputs

Output type	PNP
Output Function	NO + NC
Switching frequency	2kHz

Electrical data

Operating Voltage	10...30Vdc
No-Load supply current	≤ 10mA
Load current	≤ 200mA
Leakage current	≤ 10μA
Output voltage drop	≤ 1,8V @200mA
Max ripple content	≤10%
LED indicators	Yellow LED output state
Time delay before availability	≤ 50ms
Short-circuit protection	Yes
Reverse Polarity Protection	Yes
Protection against inductive loads	Yes

Mechanical data

Mounting	Shielded
Dimensions	M12 x 1 / L= 64,8mm
Weight	30g
Housing Material	Nickel-plated brass
Connections	M12 plug
Active Head Material	PBT
Tightening torque	10Nm
Operating temperature	-25°C...+70°C
Diameter/Dimension	M12

Test/Approvals

Approvals	CE UR
EMC compatibility	IEC 60947-5-2
Shocks and vibrations	Vibration IEC 60068-2-6 / Shock IEC 60068-2-27
Degree of protection	IP67

Accessories

Supplied Accessories	2 nuts M12x1
----------------------	--------------

INSTALLATION

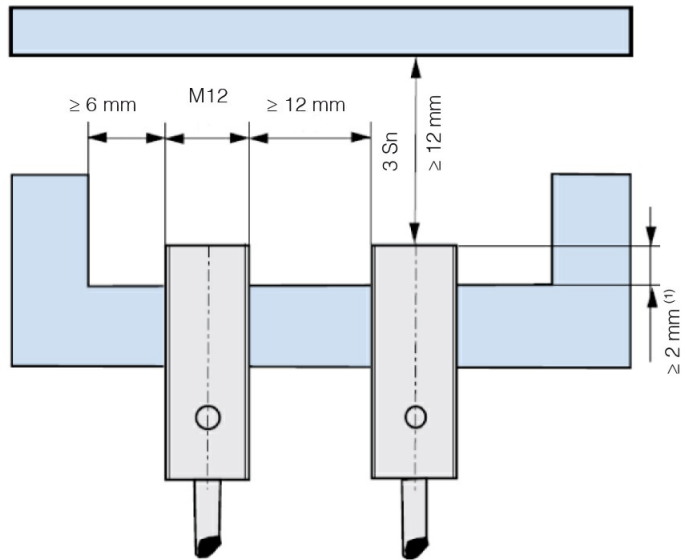

⁽¹⁾ $\geq 0,8 \text{ mm}$ for non magnetic materials

RESPONSE CURVES

Disassamento Parallelo

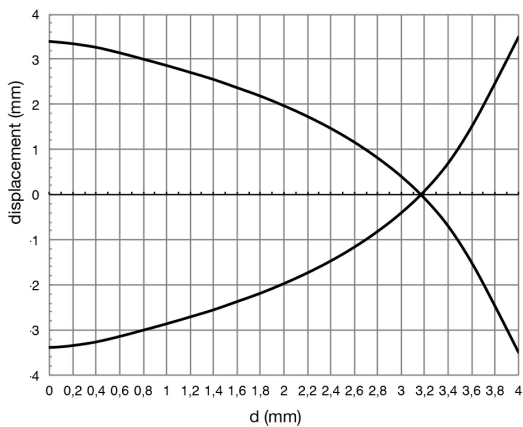

M.D. Micro Detectors S.p.A.

Strada S. Caterina, 235

41122 Modena (MO)

Tel. 059 420411

Fax 059 253973

E-mail info@microdetectors.com

date of printing

21/05/2020 07:33:50