

Flush Silhouette Switches

# LB/LBW Series

ø16mm

## LB Series



Projects only 2mm from the panel surface. For sleek and refined style.



• See website for details on approvals and standards.

Thinnest in the industry



[Shape]

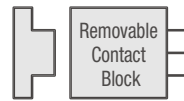

[Contact Rating]

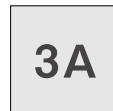





[Action]



[Operating Stroke]



	Series	page
	Flush Silhouette Switches LB Series	<b>B-073</b>
	Flush Silhouette Switches LBW Series	<b>B-091</b>
	ø16mm LB Series	<b>B-103</b>
	UP Series	<b>B-123</b>

For more information, visit <http://eu.idec.com>

# Stylish and Functional

IDEC's extensive range of LB/LBW series switches can be used for a wide range of applications.

## Flush Silhouette

### Flush Silhouette

Projects only 2mm from the panel surface. For sleek and refined style.



### LB Series Flush Silhouette Switches

Slim 2mm-thick bezels for stylish panels.

### LBW Series Flush Silhouette Switches

Smart appearance with large surface for secure operation.



## Control Unit

### ø16mm LB Series Miniature Switches and Pilot Lights

Short body for space-saving installation.

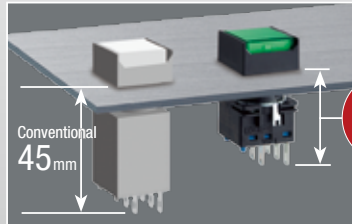

**27.9mm** Short Body  
Depth of only 27.9mm behind panel. Reduces the size of machines and control panels.

Compact

## Flush Silhouette & Control Unit

### Removable Contact Block /Single Board Mounting

Removable contacts enable easy wiring / Single board mounting for space-saving installation.

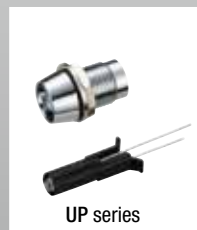
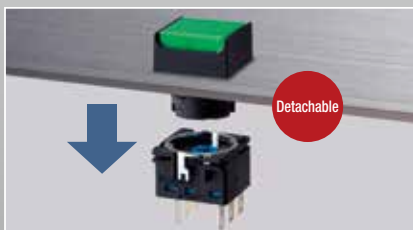

Separate & One Board

UP series has the same depth as LB/LBW series. Mounts on the same panel. (Flush bezel: 34.9mm, standard bezel: 27.9mm)

**Waterproof**  
Degree of protection: IP65

Waterproof



APEM

Switches & Pilot Lights

Control Boxes

Emergency Stop Switches

Enabling Switches

Safety Products

Explosion Proof

Terminal Blocks

Relays & Sockets

Circuit Protectors

Power Supplies

LED Illumination

Controllers

Operator Interfaces

Sensors

AUTO-ID

Flush Silhouette

ø16

ø22

ø30

Miniature

Pilot Lights

CW

LW-F

LB

LBW

UP

Flush Bezel

# LB-SERIES | Flush Silhouette Switches

## Flush Silhouette Switches

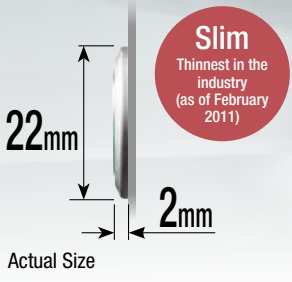

**Slim**  
Thinnest in the industry  
(as of February 2011)

Protection degree: IP65 (IEC 60529)

**point** For sleek and refined style

\* Panel cutout (mm)

- APEM
- Switches & Pilot Lights
- Control Boxes
- Emergency Stop Switches
- Enabling Switches
- Safety Products
- Explosion Proof
- Terminal Blocks
- Relays & Sockets
- Circuit Protectors
- Power Supplies
- LED Illumination
- Controllers
- Operator Interfaces
- Sensors
- AUTO-ID

- Flush Silhouette
- ø16
- ø22
- ø30
- Miniature
- Pilot Lights

- CW
- LW-F
- LB**
- LBW
- UP
- Flush Bezel



### Illuminated Pushbuttons

Illuminated pushbuttons with switch guard available



### Pushbuttons

Marking plates can be used with lens style pushbuttons



Pushbuttons with switch guard available

\*Does not light on.

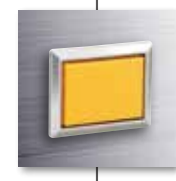

### Pilot Lights



### Dome Pilot Lights



### Selector Switches

2-position and 3-position selector switches. Maintained and other various spring return actions available.

\*Photo: lever operator (knob operator also available)

Illuminated selector switches available



**Key Selectors**  
ensure safety

Wave Key

Seven different keys to choose from. Key removable in desired positions.



### Buzzer

Protection degree: IP54  
Steady sound at 80 dB minimum (at 0.1m)



### Lever Switches

Degree of protection: IP67  
Up/down operation.  
2- and 3-positions available.  
For 3-position switches, maintained and return two-way actions available.



Black bezel only

# Flush Silhouette Switches LB Series

Flush bezel projects only 2 mm from front of panel.

**Contact Ratings** (See B-120 for approval ratings)

**Gold Contact (switch base: blue)**

Rated Insulation Voltage		250V	
Rated Thermal Current		3A	
Rated Operating Voltage		30V DC	125V AC
Rated Operating Current (electrical life: 100,000 operations)	Resistive Load	0.1A	0.1A
Contact Material		Gold plated silver	

- Minimum applicable load (reference value): 5V AC/DC, 1 mA  
Applicable range is subject to the operating conditions and load.
- See electrical life in Specifications.

**Silver Contact (switch base: gray)**

Rated Insulation Voltage		250V				
Rated Operating Voltage		30V	125V	250V		
Rated Operating Current	Electrical Life 50,000 operations	AC 50/60Hz	Resistive load	—	5A	5A
			Inductive load	—	3A	1.5A
		DC	Resistive load	5A	1.1A	—
	Inductive load		2A	0.4A	—	
	Electrical Life 100,000 operations	AC 50/60Hz	Resistive load	—	5A	3A
			Inductive load	—	3A	1.5A
DC		Resistive load	3A	0.6A	—	
	Inductive load	1A	0.22A	—		
Rated Thermal Current		5A				
Contact Material		Silver				

- AC inductive load: PF=0.6 to 0.7 DC inductive load: L/R=7 ms max.

## LED Ratings

Rated Voltage	5V DC	12V AC/DC	24V AC/DC
Voltage Range	5V DC±5%	12V AC/DC±10%	24V AC/DC ±10%
LED Part No.	LB9Z-LED5②	LB9Z-LED1②	LB9Z-LED2②
Current Draw	A, R: 18 mA G, S: 6 mA PW: 5 mA		
Voltage Marking	Marked on the side of the LED unit		
LED Life (reference value)	Approx. 30,000 hours [until the brightness reduces to 50% of the initial value when lit at the rated voltage (direct current) under 25°C environment.]		
Internal Circuit	A, G, R, PW, S		

- ② (color code): A (amber), G (green), PW (pure white), R (red), S (blue)
- Use the pure white (PW) module for yellow illumination.
- LED lamp contains a current-limiting resistor.



## Specifications

Operating Temperature	-25 to +60°C (no freezing) Illuminated units: -25 to +55°C	
Storage Temperature	-30 to +80°C (no freezing)	
Operating Humidity	45 to 85% RH (no condensation)	
Contact Resistance	50 mΩ maximum (initial value)	
Insulation Resistance	100 MΩ minimum (500V DC megger)	
Dielectric Strength	Switch Unit	Between live part and ground: 2,000V AC, 1 minute Between terminals of different poles: 2,000V AC, 1 minute Between terminals of the same poles: 1,000V AC, 1 minute
	Illumination Unit	Between live part and ground: 2,000V AC, 1 minute
Vibration Resistance	Operating extremes/Damage limits: 5 to 55 Hz, amplitude 0.5 mm	
Shock Resistance	Operating extremes: 100 m/s <sup>2</sup> Damage limits: 1,000 m/s <sup>2</sup>	
Mechanical Life (minimum operations)	Momentary: 2,000,000 Maintained: 250,000 Selector switches: 250,000 Key selector switches: 250,000	
Electrical Life (minimum operations)	Momentary: 50,000 / 100,000 (*1) Maintained: 50,000 / 100,000 (*2) Selector switches: 50,000 / 100,000 (*2) Key selector switches: 50,000 / 100,000 (*2)	
Degree of Protection	IP65 (IEC 60529)	
Terminal Style	Solder/tab terminal #110 PC board terminal	
Weight (approx.)	14g (LB8L-M1T24)	
	13g (LB8P-1T04)	
	13g (LB8B-M1T2)	
	15g (LB8S-2T2)	
	27g (LB8K-2ST2A)	
	15g (LB8GL-M1T24) 14g (LB8GB-M1T2)	

\*1: Switching frequency 1,800 operations/h.

\*2: Switching frequency 1,200 operations/h.

APEM

Switches & Pilot Lights

Control Boxes

Emergency Stop Switches

Enabling Switches

Safety Products

Explosion Proof

Terminal Blocks

Relays & Sockets

Circuit Protectors

Power Supplies

LED Illumination

Controllers

Operator Interfaces

Sensors

AUTO-ID

Flush Silhouette

ø16

ø22

ø30

Miniature

Pilot Lights

CW

LW-F

LB

LBW

UP

Flush Bezel



## Illuminated Pushbuttons

Package Quantity:1

## Solder/Tab Terminal

① Shape	② Operation	③ Contact	④ LED Operating Voltage	Part No.	* Illumination Color Code
Black bezel	Momentary	Gold/SPDT	24V AC/DC	LB $\odot$ L-M1T14*	Specify the color code in place of * in the Part No.  A: amber G: green PW: pure white R: red S: blue Y: yellow
		Gold/DPDT		LB $\odot$ L-M1T24*	
Maintained	Gold/SPDT	24V AC/DC	LB $\odot$ L-A1T14*		
	Gold/DPDT		LB $\odot$ L-A1T24*		
Metallic bezel	Momentary	Gold/SPDT	24V AC/DC	LB $\odot$ L-M1T14*	
		Gold/DPDT		LB $\odot$ L-M1T24*	
	Maintained	Gold/SPDT	24V AC/DC	LB $\odot$ L-A1T14*	
		Gold/DPDT		LB $\odot$ L-A1T24*	
Guard Type	Momentary	Gold/SPDT	24V AC/DC	LB $\odot$ L-M1T14*	
		Gold/DPDT		LB $\odot$ L-M1T24*	
	Maintained	Gold/SPDT	24V AC/DC	LB $\odot$ L-A1T14*	
		Gold/DPDT		LB $\odot$ L-A1T24*	

- Illuminated pushbuttons contain an LED unit. For details on LED units, see **B-130**.
- The guard opens 180 degrees spring-return.
- Illuminated pushbuttons can be used with legend markings. Engraving can be done on a marking plate which is placed in the lens, or a clear film can be printed and placed in the lens. See **B-133** for details on the marking plate and film.
- PC board terminals available for gold contacts. Silver contacts also available. To specify, see Part Number Development below.
- 5V DC and 12V AC/DC LED operating voltages also available.
- Other bezel sizes available (LBW series). For details, see **B-093**.

## Part Number Development

LB $\odot$ L-②1T③④⑤\*

## ① Shape

Code	Shape
6	Round / Black Bezel
7	Square / Black Bezel
8	Rectangular / Black Bezel
6M	Round / Metallic Bezel
7M	Square / Metallic Bezel
8M	Rectangular / Metallic Bezel
6G	Round with Guard
7G	Square with Guard
8G	Rectangular with Guard

## ② Operation

Code	Operation
A	Maintained
M	Momentary

## ③ Contacts

Code	Contact
1	Gold/SPDT
2	Gold/DPDT
5	Silver/SPDT
6	Silver/DPDT

## ④ LED Operating Voltage

Code	Rated Operating Voltage
1	5V DC
3	12V AC/DC
4	24V AC/DC

## ⑤ Others

Code	Specification	Part No. Example
Blank	Solder/Tab Terminal	—
V	PC Board Terminal (Gold Contact Only)	LB6L-M1T14V*

- Specify the color code in place of \* in the table above.

- APEM
- Switches & Pilot Lights
- Control Boxes
- Emergency Stop Switches
- Enabling Switches
- Safety Products
- Explosion Proof
- Terminal Blocks
- Relays & Sockets
- Circuit Protectors
- Power Supplies
- LED Illumination
- Controllers
- Operator Interfaces
- Sensors
- AUTO-ID

- Flush Silhouette
- ø16
- ø22
- ø30
- Miniature
- Pilot Lights
- CW
- LW-F
- LB
- LBW
- UP
- Flush Bezel

Dimensions

All dimensions in mm.

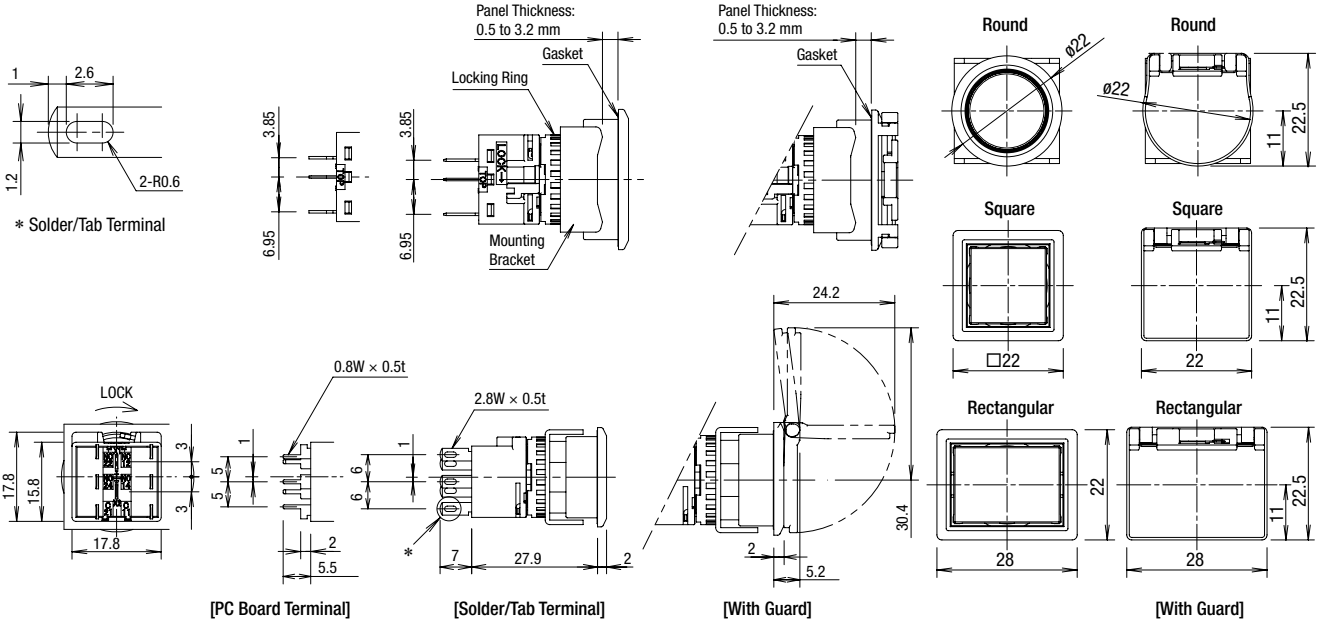

Terminal Arrangement (Bottom View)

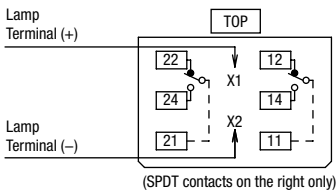

Panel Cut-out for Positioning Round (LB6L/LB6ML/LB6GL)

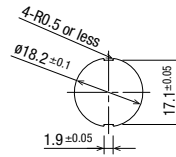

Mounting Hole Layout

Round (LB6L/LB6ML/LG6GL)

Square (LB7L/LB7ML/LB7GL)

Square (LB8L/LB8ML/LB8GL)

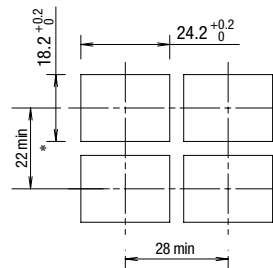
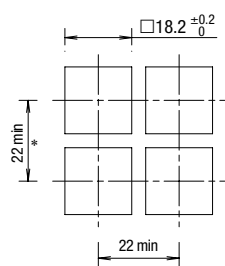
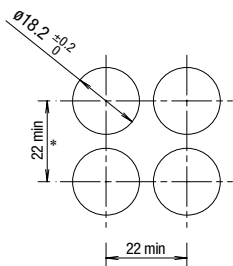









\* 45 mm minimum for switches with guard  
 Note: When using rubber boot or terminal cover, see dimensions on B-127 and B-128.

- For details on pc board and circuit design, see B-121.
- For details on single board mounting, see B-122.

## Pilot Lights

Package Quantity:1

## Solder/Tab Terminal

Part No. / Shape	LB①P-②T③④*							
								
	Round / Black Bezel	Square / Black Bezel	Rectangular / Black Bezel	Round / Metallic Bezel	Dome / Black Bezel	Square / Metallic Bezel	Rectangular / Metallic Bezel	Dome / Metallic Bezel
② Lens Shape	① Shape	③ LED Operating Voltage	Part No.	* Illumination Color Code				
Flush	Black Bezel	24V AC/DC	LB①P-1T04*	Specify the color code in place of * in the Part No. A: amber G: green PW: pure white R: red S: blue Y: yellow				
	Metallic Bezel	24V AC/DC	LB①P-1T04*					
Dome	Black Bezel	24V AC/DC	LB6P-2T04*					
	Metallic Bezel	24V AC/DC	LB6MP-2T04*					

- Pilot lights contain an LED unit. For maintenance LED units see **B-130**.
- Legends and symbols can be engraved on a marking plate or film to be inserted under the lens by users for labelling purposes. See **B-133** for details.
- PC board terminals available. To specify, see Part Number Development below.
- 5V DC and 12V AC/DC LED operating voltages also available.
- Other bezel sizes available (LBW series). For details, see **B-095**.

## Part Number Development

## LB①P-②T③④\*

## ① Shape

Code	Shape
6	Round / Black Bezel
7	Square / Black Bezel
8	Rectangular / Black Bezel
6M	Round / Metallic Bezel
7M	Square / Metallic Bezel
8M	Rectangular / Metallic Bezel

- Round only for dome.

## ② Lens Shape

Code	Lens Shape
1	Flush
2	Dome

## ③ LED Operating Voltage

Code	Rated Operating Voltage
1	5V DC
3	12V AC/DC
4	24V AC/DC

## ④ Others

Code	Specification	Part No. Example
Blank	Solder/Tab Terminal	—
V	PC Board Terminal	LB6P-1T04V*

- Specify the color code in place of \* in the table above.

Dimensions

All dimensions in mm.

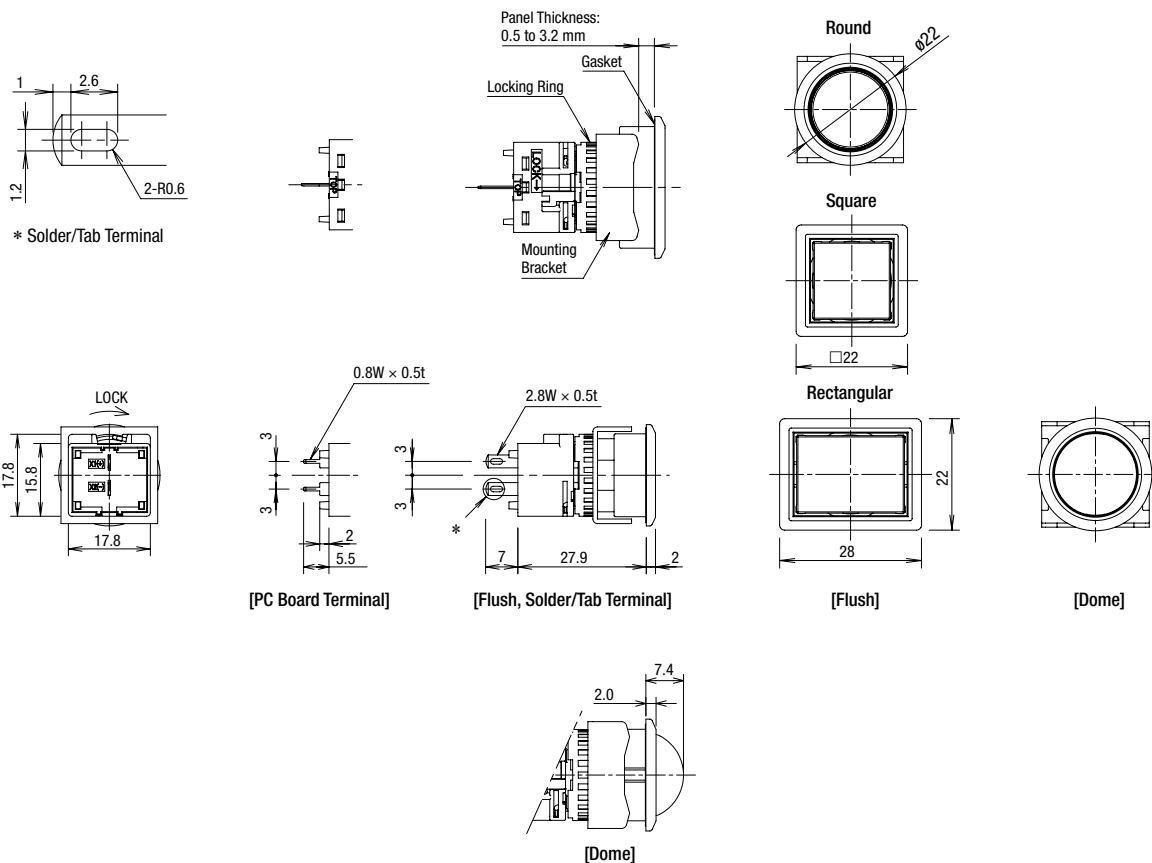

APEM

Switches & Pilot Lights

Control Boxes

Emergency Stop Switches

Enabling Switches

Safety Products

Explosion Proof

Terminal Blocks

Relays & Sockets

Circuit Protectors

Power Supplies

LED Illumination

Controllers

Operator Interfaces

Sensors

AUTO-ID

Terminal Arrangement (Bottom View)

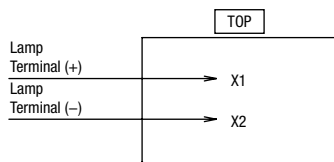

Panel Cut-out for Positioning

Round (LB6P/LB6MP)

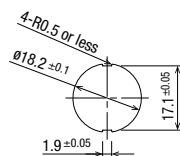

Mounting Hole Layout

Round (LB6P/LB6MP)

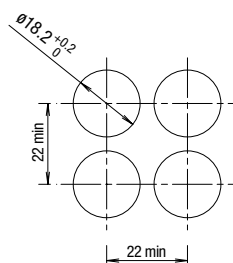

Square (LB7P/LB7MP)

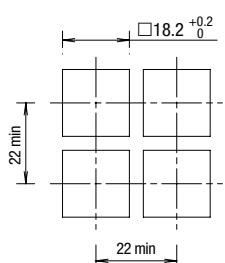

Square (LB8P/LB8MP)

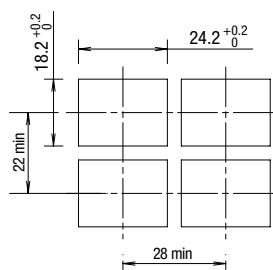

Note: When using rubber boot or terminal cover, see dimensions on B-127 and B-128.

Flush Silhouette

ø16

ø22

ø30

Miniature

Pilot Lights

CW

LW-F

LB

LBW

UP

Flush Bezel

- For details on pc board and circuit design, see B-121.
- For details on single board mounting, see B-122.



## Flush Silhouette Switches LB Series

## Pushbuttons

Solder/Tab Terminal

Package Quantity:1

① Shape	Button Style	② Operation	③ Contact	Part No.		* Color Code
				Gold Contact	Silver Contact	
Black bezel	Button	Momentary	SPDT	LB⓪B-M1T1*	LB⓪B-M1T5*	B: black G: green R: red S: blue W: white Y: yellow
			DPDT	LB⓪B-M1T2*	LB⓪B-M1T6*	
			3PDT	LB⓪B-M1T3*	LB⓪B-M1T7*	
		Maintained	SPDT	LB⓪B-A1T1*	LB⓪B-A1T5*	
			DPDT	LB⓪B-A1T2*	LB⓪B-A1T6*	
			3PDT	LB⓪B-A1T3*	LB⓪B-A1T7*	
	Lens	Momentary	SPDT	LB⓪B-M1T1L*	LB⓪B-M1T5L*	A: amber G: green R: red S: blue W: white Y: yellow
			DPDT	LB⓪B-M1T2L*	LB⓪B-M1T6L*	
			3PDT	LB⓪B-M1T3L*	LB⓪B-M1T7L*	
		Maintained	SPDT	LB⓪B-A1T1L*	LB⓪B-A1T5L*	
			DPDT	LB⓪B-A1T2L*	LB⓪B-A1T6L*	
			3PDT	LB⓪B-A1T3L*	LB⓪B-A1T7L*	
Metallic bezel	Button	Momentary	SPDT	LB⓪B-M1T1*	LB⓪B-M1T5*	B: black G: green R: red S: blue W: white Y: yellow
			DPDT	LB⓪B-M1T2*	LB⓪B-M1T6*	
			3PDT	LB⓪B-M1T3*	LB⓪B-M1T7*	
		Maintained	SPDT	LB⓪B-A1T1*	LB⓪B-A1T5*	
			DPDT	LB⓪B-A1T2*	LB⓪B-A1T6*	
			3PDT	LB⓪B-A1T3*	LB⓪B-A1T7*	
	Lens	Momentary	SPDT	LB⓪B-M1T1L*	LB⓪B-M1T5L*	A: amber G: green R: red S: blue W: white Y: yellow
			DPDT	LB⓪B-M1T2L*	LB⓪B-M1T6L*	
			3PDT	LB⓪B-M1T3L*	LB⓪B-M1T7L*	
		Maintained	SPDT	LB⓪B-A1T1L*	LB⓪B-A1T5L*	
			DPDT	LB⓪B-A1T2L*	LB⓪B-A1T6L*	
			3PDT	LB⓪B-A1T3L*	LB⓪B-A1T7L*	
Guard Type	Button	Momentary	SPDT	LB⓪B-M1T1*	LB⓪B-M1T5*	B: black G: green R: red S: blue W: white Y: yellow
			DPDT	LB⓪B-M1T2*	LB⓪B-M1T6*	
			3PDT	LB⓪B-M1T3*	LB⓪B-M1T7*	
		Maintained	SPDT	LB⓪B-A1T1*	LB⓪B-A1T5*	
			DPDT	LB⓪B-A1T2*	LB⓪B-A1T6*	
			3PDT	LB⓪B-A1T3*	LB⓪B-A1T7*	
	Lens	Momentary	SPDT	LB⓪B-M1T1L*	LB⓪B-M1T5L*	A: amber G: green R: red S: blue W: white Y: yellow
			DPDT	LB⓪B-M1T2L*	LB⓪B-M1T6L*	
			3PDT	LB⓪B-M1T3L*	LB⓪B-M1T7L*	
		Maintained	SPDT	LB⓪B-A1T1L*	LB⓪B-A1T5L*	
			DPDT	LB⓪B-A1T2L*	LB⓪B-A1T6L*	
			3PDT	LB⓪B-A1T3L*	LB⓪B-A1T7L*	

- CW • The guard opens 180 degrees spring-return.
- LW-F • Pushbuttons can be used with legend markings. Engraving can be done on a marking plate which is placed in the lens, or a clear film can be printed and placed in the lens. See **B-133** for details on the marking plate and film.
- LB • Black is available for lens. Black lens consists of a transparent lens and a black marking plate. To specify, see Part Number Development below.
- LBW • PC board terminals available for gold contacts. To specify, see Part Number Development below.
- UP • Other bezel sizes available (LBW series). For details, see **B-097**.

## Part Number Development

LB⓪B-②1T③④\*

## ① Shape

Code	Shape
6	Round / Black Bezel
7	Square / Black Bezel
8	Rectangular / Black Bezel
6M	Round / Metallic Bezel
7M	Square / Metallic Bezel
8M	Rectangular / Metallic Bezel
6G	Round with Guard
7G	Square with Guard
8G	Rectangular with Guard

## ② Operation

Code	Operation
A	Maintained
M	Momentary

## ③ Contacts

Code	Contact	Code	Contact
1	Gold/SPDT	5	Silver/SPDT
2	Gold/DPDT	6	Silver/DPDT
3	Gold/3PDT	7	Silver/3PDT

## ④ Others

Code	Specification	Part No. Example
Blank	Solder/Tab Terminal	—
B	Black Translucent Lens (Lens Only)	LB6B-M1T1LB
V	PC Board Terminal (Gold Contact Only)	LB6B-M1T1V*

For more information, visit <http://eu.idec.com>

APEM  
Switches & Pilot Lights  
Control Boxes  
Emergency Stop Switches  
Enabling Switches  
Safety Products  
Explosion Proof  
Terminal Blocks  
Relays & Sockets  
Circuit Protectors  
Power Supplies  
LED Illumination  
Controllers  
Operator Interfaces  
Sensors  
AUTO-ID

Flush Silhouette  
ø16  
ø22  
ø30  
Miniature  
Pilot Lights

CW  
LW-F  
LB  
LBW  
UP  
Flush Bezel

Dimensions

All dimensions in mm.

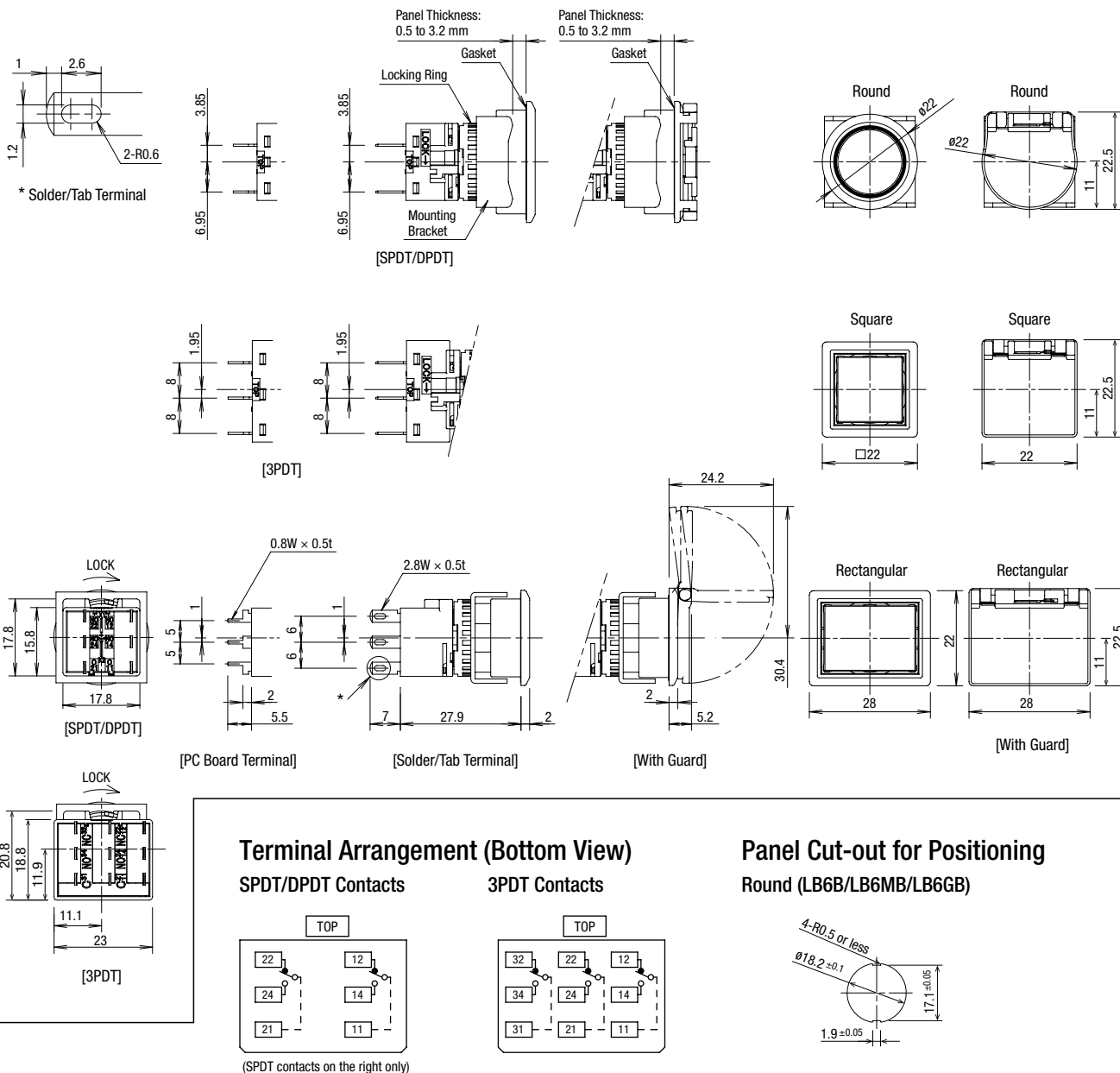

Mounting Hole Layout

Round (LB6B/LB6MB/LB6GB)

Square (LB7B/LB7MB/LB7GB)

Rectangular (LB8B/LB8MB/LB8GB)

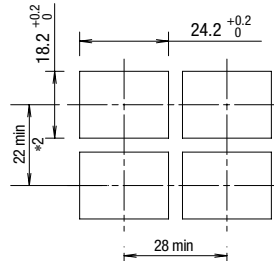
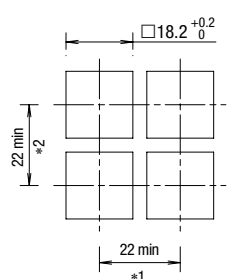
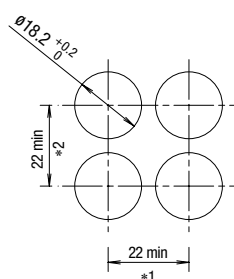

\*1: 23.2 mm minimum for 3PDT

\*2: 45 mm minimum for switches with guard

Note: When using rubber boot or terminal cover, see dimensions on B-127 and B-128.

- For details on pc board and circuit design, see B-121.
- For details on single board mounting, see B-122.



Download catalogs and CAD from <http://eu.idec.com/downloads>

## Selector Switches

Solder/Tab Terminal

Package Quantity:1

① Shape	② Operator Position		③ Contact	Part No.	
				Gold Contact	Silver Contact
Black bezel	90° 2-position	Maintained 	SPDT	LB⓪S-2T1	LB⓪S-2T5
			DPDT	LB⓪S-2T2	LB⓪S-2T6
			3PDT	LB⓪S-2T3	LB⓪S-2T7
	45° 3-position	Maintained 	DPDT	LB⓪S-3T2	LB⓪S-3T6
			3PDT	LB⓪S-3T3	LB⓪S-3T7
		Spring return two-way 	DPDT	LB⓪S-33T2	LB⓪S-33T6
Metallic bezel	90° 2-position	Maintained 	SPDT	LB⓪S-2T1	LB⓪S-2T5
			DPDT	LB⓪S-2T2	LB⓪S-2T6
			3PDT	LB⓪S-2T3	LB⓪S-2T7
	45° 3-position	Maintained 	DPDT	LB⓪S-3T2	LB⓪S-3T6
			3PDT	LB⓪S-3T3	LB⓪S-3T7
		Spring return two-way 	DPDT	LB⓪S-33T2	LB⓪S-33T6
3PDT	LB⓪S-33T3	LB⓪S-33T7			

- Lever operators also available. To specify, see Part Number Development below.
- PC board terminals available for gold contacts. To specify, see Part Number Development below.
- 2-position spring return from right, 3-position spring return from right, and 3-position spring return from left also available. To specify, see Part Number Development below.
- For contact operation, see B-119.
- Other bezel sizes available (LBW series). For details, see B-099.

## Part Number Development

LB①S-②③T④⑤

## ① Shape

Code	Shape
6	Round / Black Bezel
7	Square / Black Bezel
8	Rectangular / Black Bezel
6M	Round / Metallic Bezel
7M	Square / Metallic Bezel
8M	Rectangular / Metallic Bezel

## ② Operator Position

## 2-position

Operator Position	
2 Maintained 	21 Spring return from right 

## 3-position

Operator Position			
3 Maintained 	31 Spring return from right 	32 Spring return from left 	33 Spring return two-way 

## ③ Operator

Code	Operator Shape
Blank	Knob
L	Lever

## ④ Contacts

Code	Contact
1	Gold/SPDT (90° 2-position only)
2	Gold/DPDT
3	Gold/3PDT
5	Silver/SPDT (90° 2-position only)
6	Silver/DPDT
7	Silver/3PDT

## ⑤ Others

Code	Specification	Part No. Example
Blank	Solder/Tab Terminal	—
V	PC Board Terminal (Gold Contact Only)	LB6S-2T1V

APEM  
Switches & Pilot Lights  
Control Boxes  
Emergency Stop Switches  
Enabling Switches  
Safety Products  
Explosion Proof  
Terminal Blocks  
Relays & Sockets  
Circuit Protectors  
Power Supplies  
LED Illumination  
Controllers  
Operator Interfaces  
Sensors  
AUTO-ID

Flush Silhouette  
ø16  
ø22  
ø30  
Miniature  
Pilot Lights

CW  
LW-F  
LB  
LBW  
UP  
Flush Bezel

Dimensions

All dimensions in mm.

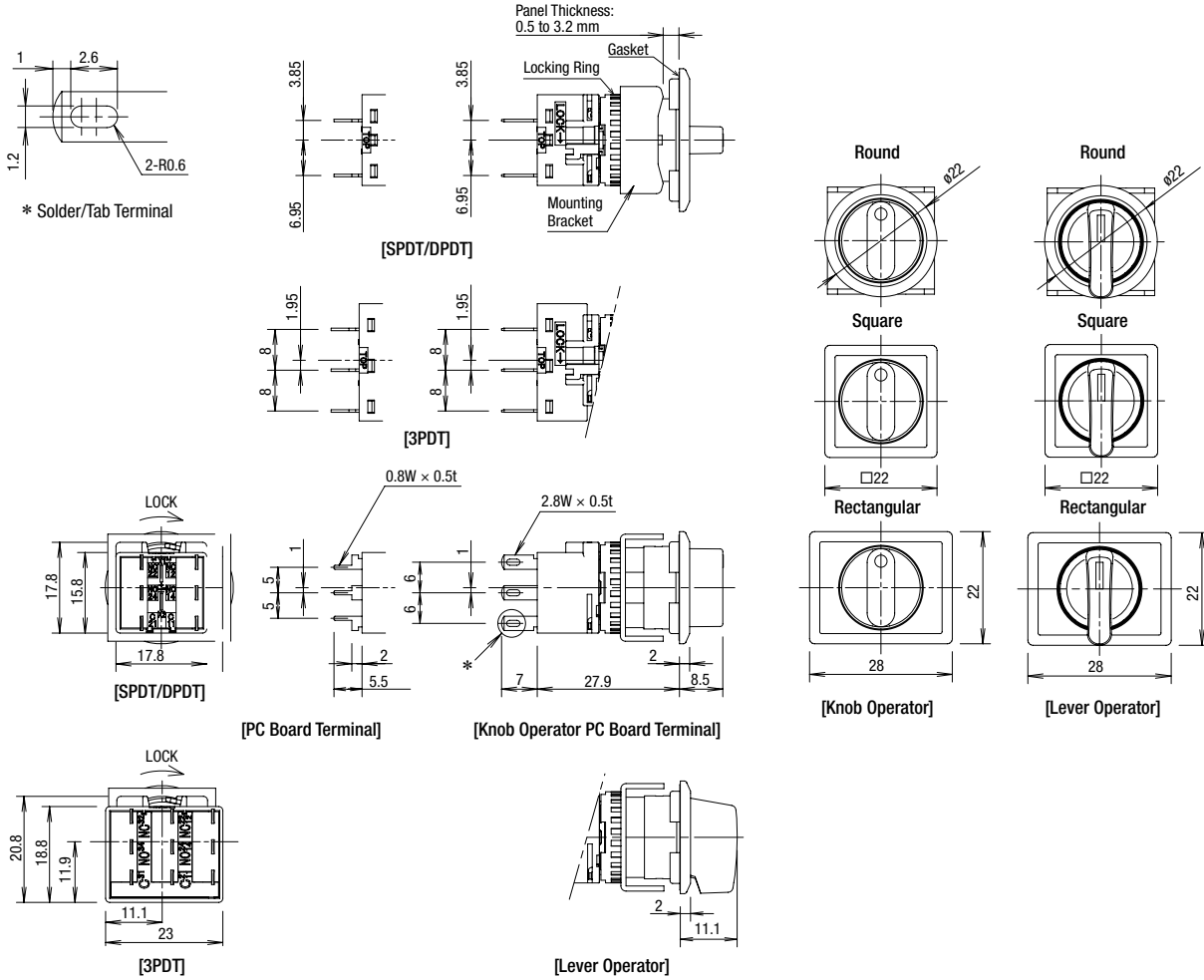

Terminal Arrangement (Bottom View)

SPDT/DPDT Contacts

3PDT Contacts

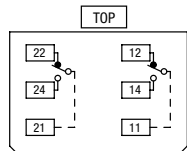

(SPDT contacts on the right only)

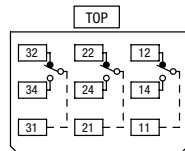

Panel Cut-out for Positioning

Round (LB6S/LB6MS)

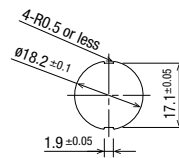

Mounting Hole Layout

Round (LB6S/LB6MS)

Square (LB7S/LB7MS)

Rectangular (LB8S/LB8MS)

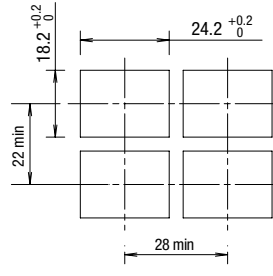
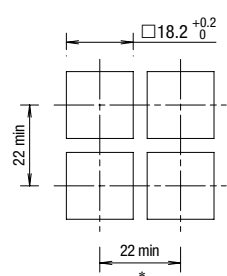
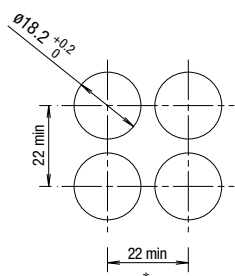

\*: 23.2 mm minimum for 3PDT

Note: When using rubber boot or terminal cover, see dimensions on B-128.

- For details on pc board and circuit design, see B-121.
- For details on single board mounting, see B-122.





Download catalogs and CAD from <http://eu.idec.com/downloads>

## Illuminated Selector Switches

Solder/Tab Terminal

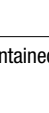
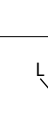
Package Quantity:1

① Shape	② Operator Position		③ Contact	④ LED Operating Voltage	Part No.		* Illumination Color Code
					Gold Contact	Silver Contact	
Black bezel	90° 2-position	Maintained 	SPDT	24V AC/DC	LB①F-2T14*	LB①F-2T54*	Specify the color code in place of * in the Part No.  G: green R: red PW: pure white
			DPDT	24V AC/DC	LB①F-2T24*	LB①F-2T64*	
Metallic bezel	45° 3-position	Maintained 	DPDT	24V AC/DC	LB①F-3T24*	LB①F-3T64*	
			SPDT	24V AC/DC	LB①F-2T14*	LB①F-2T54*	
	90° 2-position	Maintained 	DPDT	24V AC/DC	LB①F-2T24*	LB①F-2T64*	
			SPDT	24V AC/DC	LB①F-2T14*	LB①F-2T54*	
45° 3-position	Maintained 	DPDT	24V AC/DC	LB①F-3T24*	LB①F-3T64*		

- Illuminated selector switches contain an LED unit. For maintenance LED units see **B-130**.
- PC board terminals available for gold contacts. To specify, see Part Number Development below.
- 5V DC and 12V AC/DC LED operating voltages also available. To specify, see Part Number Development below.
- For contact operation, see **B-119**.

## Part Number Development

LB①F-②T③④⑤\*

## ① Shape

Code	Shape
6	Round / Black Bezel
6M	Round / Metallic Bezel

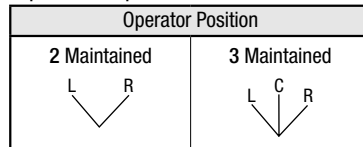
② Operator Position  
2-position 3-position

## ③ Contacts

Code	Contact
1	Gold/SPDT (90° 2-position only)
2	Gold/DPDT
5	Silver/SPDT (90° 2-position only)
6	Silver/DPDT

## ④ LED Operating Voltage

Code	Rated Operating Voltage
1	5V DC
3	12V AC/DC
4	24V AC/DC

## ⑤ Others

Code	Specification	Part No. Example
Blank	Solder/Tab Terminal	—
V	PC Board Terminal (Gold Contact Only)	LB6F-2T14V*

- Specify a color code in place of \* in the Part No.

- APEM
- Switches & Pilot Lights
- Control Boxes
- Emergency Stop Switches
- Enabling Switches
- Safety Products
- Explosion Proof
- Terminal Blocks
- Relays & Sockets
- Circuit Protectors
- Power Supplies
- LED Illumination
- Controllers
- Operator Interfaces
- Sensors
- AUTO-ID

- Flush Silhouette
- ø16
- ø22
- ø30
- Miniature
- Pilot Lights

- CW
- LW-F
- LB
- LBW
- UP
- Flush Bezel

Dimensions

All dimensions in mm.

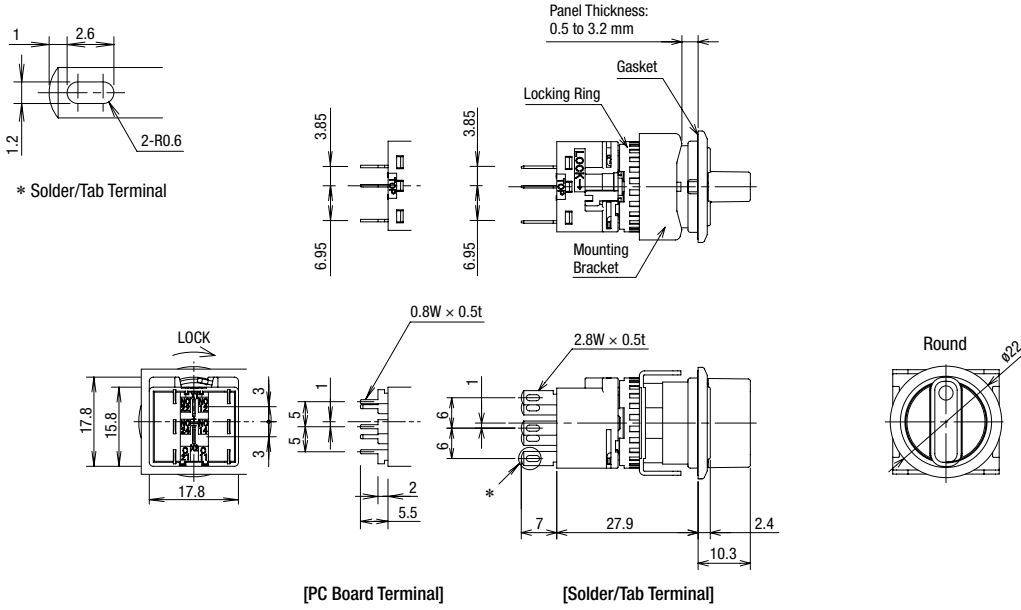

Terminal Arrangement (Bottom View)

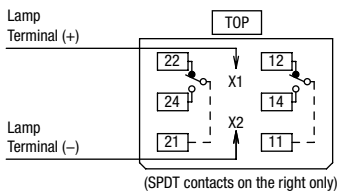

Mounting Hole Layout

Round (LB6F/LB6MF)

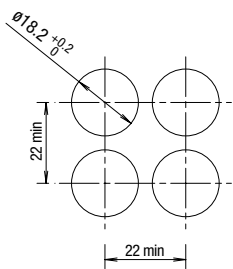

Panel Cut-out for Positioning

Round (LB6F/LB6MF)

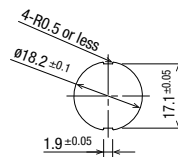











Note: When using terminal cover, see dimensions on B-128.

- For details on pc board and circuit design, see B-121.
- For details on single board mounting, see B-122.

## Key Selector Switches

Solder/Tab Terminal

Package Quantity:1

Part No. / Shape	LB ① K - ② ③ T ④ ⑤ - ⑥					
						
① Shape	② Operator Position		⑤ Key Removable Position	④ Contact	Part No.	
					Gold Contact	Silver Contact
Black bezel	90° 2-position	Maintained	A: Key removable in all positions 	SPDT	LB⊙K-2ST1A	LB⊙K-2ST5A
				DPDT	LB⊙K-2ST2A	LB⊙K-2ST6A
				3PDT	LB⊙K-2ST3A	LB⊙K-2ST7A
	45° 3-position	Maintained	A: Key removable in all positions 	DPDT	LB⊙K-3ST2A	LB⊙K-3ST6A
				3PDT	LB⊙K-3ST3A	LB⊙K-3ST7A
Metallic bezel	90° 2-position	Maintained	A: Key removable in all positions 	SPDT	LB⊙K-2ST1A	LB⊙K-2ST5A
				DPDT	LB⊙K-2ST2A	LB⊙K-2ST6A
				3PDT	LB⊙K-2ST3A	LB⊙K-2ST7A
	45° 3-position	Maintained	A: Key removable in all positions 	DPDT	LB⊙K-3ST2A	LB⊙K-3ST6A
				3PDT	LB⊙K-3ST3A	LB⊙K-3ST7A

- For operator position, see Part Number Development below.
- For key removable position, see Part Number Development below. The key cannot be removed at the return position.
- Two keys are supplied.
- Besides the standard key (key number 0H), six other keys are available. To specify, see Part Number Development below.
- Disc tumbler keys also available. Only the standard key is available. To specify, see Part Number Development below.
- PC board terminals available for gold contacts. To specify, see Part Number Development below.
- For contact operation, see **B-119**.
- Other bezel sizes available (LBW series). For details, see **B-101**.

## Part Number Development

## LB ① K - ② ③ T ④ ⑤ - ⑥

## ① Shape

Code	Shape
6	Round / Black Bezel
7	Square / Black Bezel
8	Rectangular / Black Bezel
6M	Round / Metallic Bezel
7M	Square / Metallic Bezel
8M	Rectangular / Metallic Bezel

## ② Operator Position

Code	Operator Position
2	90° 2-position maintained
21	90° 2-position spring return from right
3	45° 3-position maintained
31	45° 3-position spring return from right
32	45° 3-position spring return from left
33	45°-3-position spring return two-way

## ③ Key Style





Code	Key Style
S	Wave key
Blank	Disc tumbler key

## ④ Contacts







Code	Contact
1	Gold/SPDT (90° 2-position only)
2	Gold/DPDT
3	Gold/3PDT
5	Silver/SPDT (90° 2-position only)
6	Silver/DPDT
7	Silver/3PDT

## ⑤ Key Removal Position

## 2-position



Key Removable Position			Spring return from right
A: Key removable in all positions 	B: Key removable at left 	C: Key removable at right 	

## 3-position

Key Removable Position			
A: Key removable in all positions 	B: Key removable at left / center 	C: Key removable at center / right 	D: Key removable at center 
E: Key removable at right / left 	G: Key removable at left 	H: Key removable at right 	

For key selectors with the following operations, the key cannot be removed at the return position.

## 3-position

Spring return from right	Spring return from left	Spring return two-way
		

- Key is removable at L, C, R. Key is retained at L, C, and R.

## ⑥ Key Number

Code	Specification
Blank	Standard key (0H)
1H to 2H	Reversible key
3H to 6H	Non-reversible key

- Wave key only.

## Others

Code	Specification	Part No. Example
Blank	Solder/Tab Terminal	—
V	PC Board Terminal (Gold Contact Only)	LB6K-2ST1VA

APEM  
Switches & Pilot Lights  
Control Boxes  
Emergency Stop Switches  
Enabling Switches  
Safety Products  
Explosion Proof  
Terminal Blocks  
Relays & Sockets  
Circuit Protectors  
Power Supplies  
LED Illumination  
Controllers  
Operator Interfaces  
Sensors  
AUTO-ID

Flush Silhouette  
ø16  
ø22  
ø30  
Miniature  
Pilot Lights  
CW  
LW-F  
**LB**  
LBW  
UP  
Flush Bezel

Dimensions

All dimensions in mm.

Key Selector Switches with Wave Key

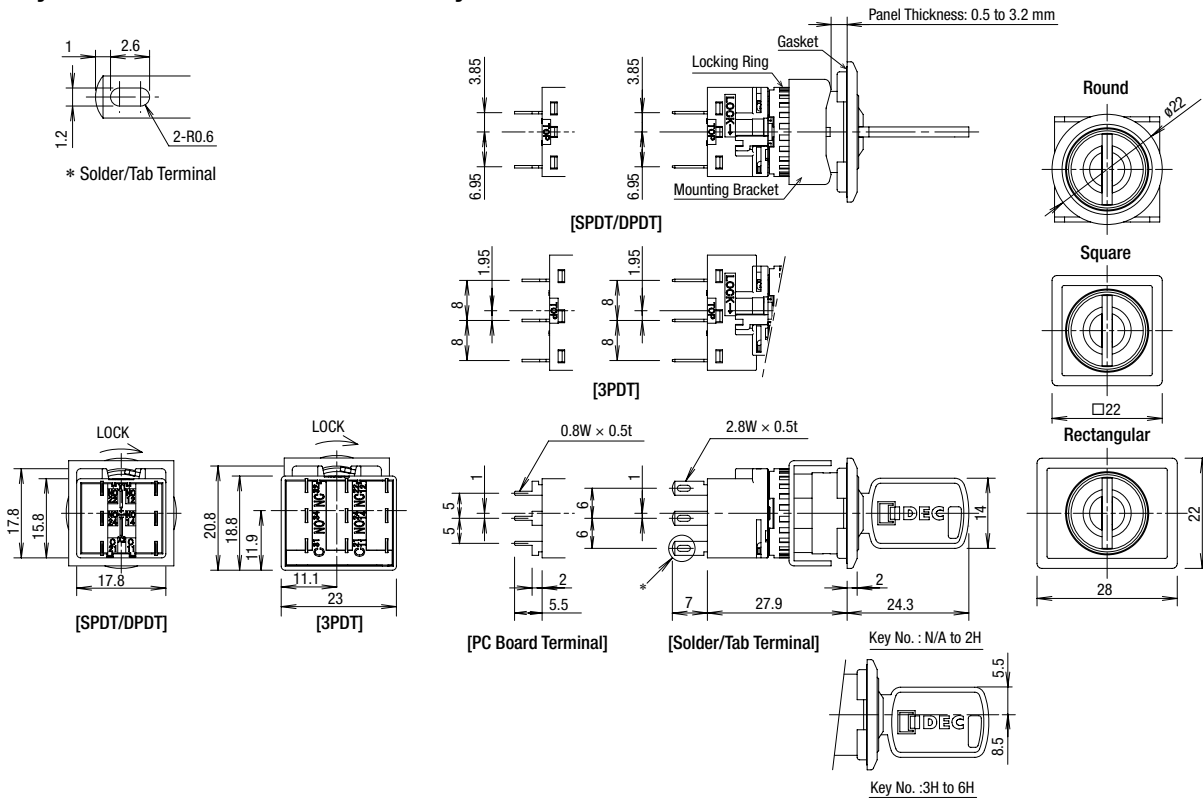

Key Selector Switches with Disc Tumbler Key

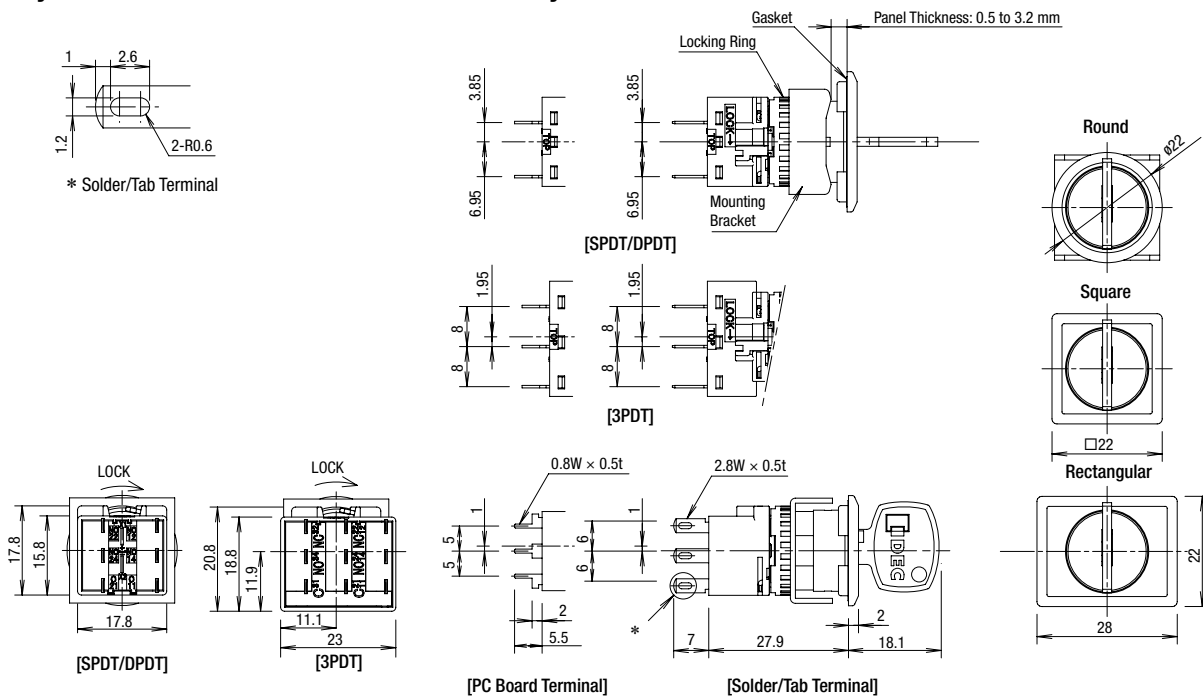

Terminal Arrangement (Bottom View)

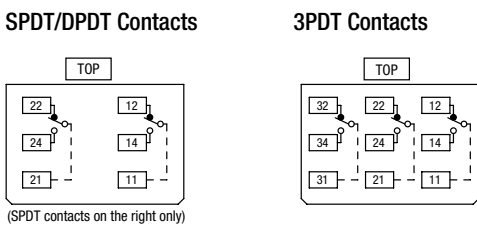



- For details on mounting hole layout, see B-120.
- For details on pc board and circuit design, see B-121.
- For details on single board mounting, see B-122.



## Lever Switches

Solder/Tab Terminal

Package Quantity: 1

Shape	Operator Position		Contact	Part No.		
				Gold Contact	Silver Contact	
Black bezel	2-position	Maintained		SPDT	LB6T-2T1	LB6T-2T5
				DPDT	LB6T-2T2	LB6T-2T6
				3PDT	LB6T-2T3	LB6T-2T7
	3-position	Maintained		DPDT	LB6T-3T2	LB6T-3T6
				3PDT	LB6T-3T3	LB6T-3T7
				DPDT	LB6T-33T2	LB6T-33T6
		Spring return from top/bottom		3PDT	LB6T-33T3	LB6T-33T7

• PC board terminals available for gold contacts. Add "V" to the Part No.  
Example: **LB6T-2T1V**

• For contact operation, see **B-119**.



Round / Black Bezel

APEM

Switches &amp; Pilot Lights

Control Boxes

Emergency Stop Switches

Enabling Switches

Safety Products

Explosion Proof

Terminal Blocks

Relays &amp; Sockets

Circuit Protectors

Power Supplies

LED Illumination

Controllers

Operator Interfaces

Sensors

AUTO-ID

Flush Silhouette

ø16

ø22

ø30

Miniature

Pilot Lights

CW

LW-F

LB

LBW

UP

Flush Bezel

APEM
Switches & Pilot Lights
Control Boxes
Emergency Stop Switches
Enabling Switches
Safety Products
Explosion Proof
Terminal Blocks
Relays & Sockets
Circuit Protectors
Power Supplies
LED Illumination
Controllers
Operator Interfaces
Sensors
AUTO-ID

Flush Silhouette
ø16
ø22
ø30
Miniature
Pilot Lights
CW
LW-F
LB
LBW
UP
Flush Bezel

Dimensions

All dimensions in mm.

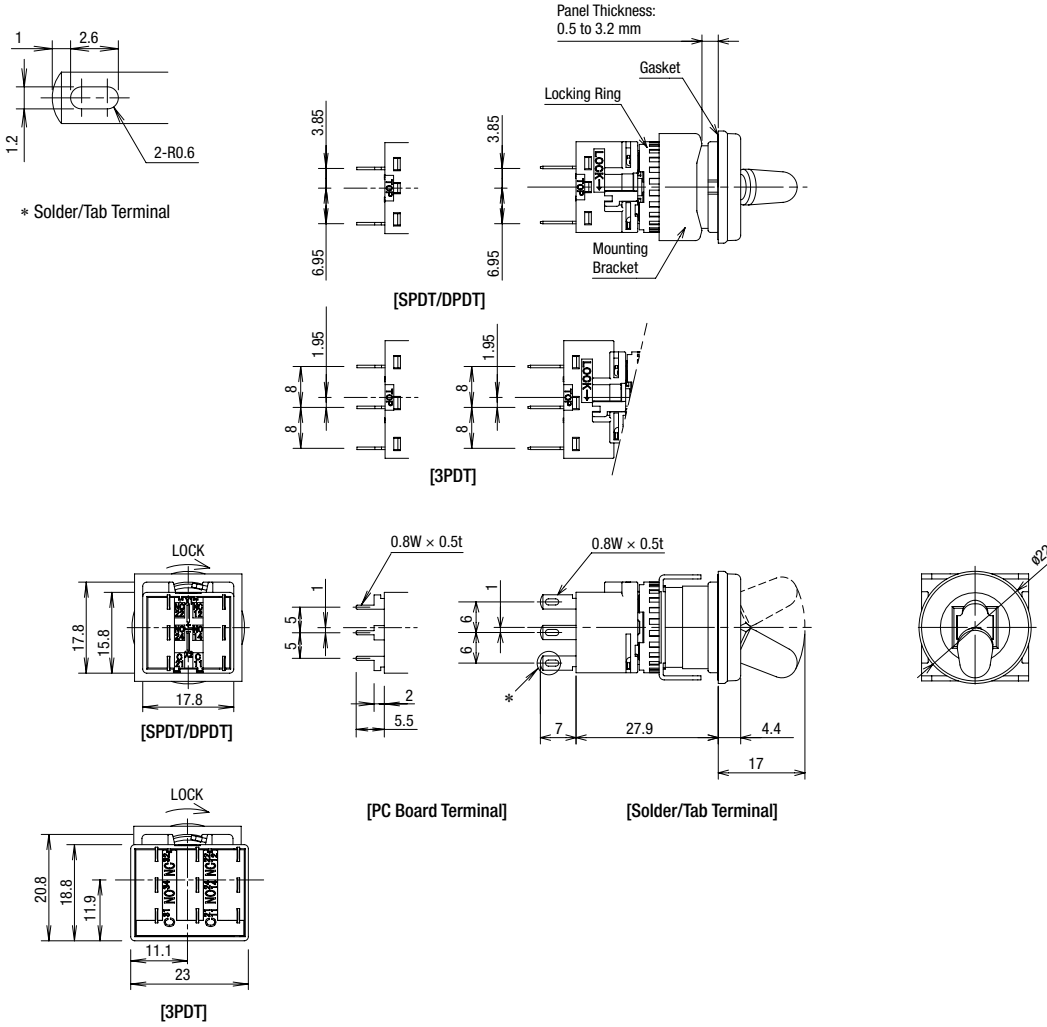

Terminal Arrangement (Bottom View)

SPDT/DPDT Contacts

3PDT Contacts

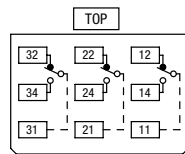
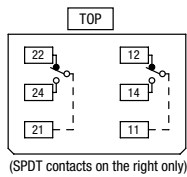

Mounting Hole Layout

Round (LB6T)

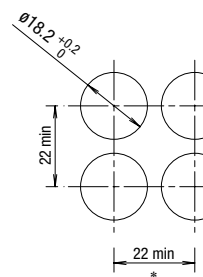

\*: 23.2 mm minimum for 3PDT  
Note: When using terminal cover, see dimensions on B-128.

Panel Cut-out for Positioning

Round (LB6T)

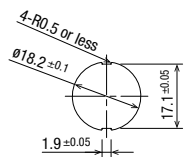

- For details on pc board and circuit design, see B-121.
- For details on single board mounting, see B-122.

## B buzzers

## Specifications

Rated Insulation Voltage	30V
Rated Operating Voltage	12, 24V DC
Operating Voltage Range	12V DC±10%, 24V DC±10%
Current Draw	26 mA
Inrush Current	80 mA maximum
Sound Pressure (at 0.1m)	Steady sound: 80 dB minimum (at the rated voltage)
Sound Frequency	2.3±0.3kHz
Response Speed	50 ms maximum
Operating Temperature	-25 to +60°C (no freezing)
Storage Temperature	-30 to +80°C(no freezing)
Operating Humidity	45 to 85% (no condensation)
Insulation Resistance	100 MΩ minimum (500V DC megger)
Dielectric Strength	Between live and dead parts: 1,000V AC, 1 minute
Vibration Resistance	Operating extremes/Damage limits: 5 to 55 Hz, amplitude 0.5 mm
Shock Resistance	Operating extremes: 100m/s <sup>2</sup> Damage limits:1,000m/s <sup>2</sup>
Life	1,000 hours minimum (beep sound)
Degree of Protection	IP54 (IEC60529)
Terminal Style	Solder/tab terminal #110 PC board terminal
Weight (approx.)	13g (round), 14g (square)

## Standards



- UL, CSA ratings: Operating voltage 12, 24V DC.
- See website for details on approvals and standards.

Package Quantity: 1

Part No. / Shape					
	Round / Black Bezel	Rectangular / Black Bezel	Round / Metallic Bezel	Rectangular / Metallic Bezel	
Shape	Operating Voltage	Degree of Protection	Part No.		
			Terminal Style		
			Solder/tab terminal	PC board terminal	
Black bezel	Round	24V DC	IP54	LB6Z-1T04	LB6Z-1T04V
	Rectangular	24V DC	IP54	LB8Z-1T04	LB8Z-1T04V
Metallic bezel	Round	24V DC	IP54	LB6MZ-1T04	LB6MZ-1T04V
	Rectangular	24V DC	IP54	LB8MZ-1T04	LB8MZ-1T04V

- 12V DC operating voltages also available. Specify "-1T04" in place of "-1T03" in the Part No.  
Example: **LB6Z-1T03**

APEM

Switches & Pilot Lights

Control Boxes

Emergency Stop Switches

Enabling Switches

Safety Products

Explosion Proof

Terminal Blocks

Relays & Sockets

Circuit Protectors

Power Supplies

LED Illumination

Controllers

Operator Interfaces

Sensors

AUTO-ID

Flush Silhouette

ø16

ø22

ø30

Miniature

Pilot Lights

CW

LW-F

LB

LBW

UP

Flush Bezel

Dimensions

All dimensions in mm.

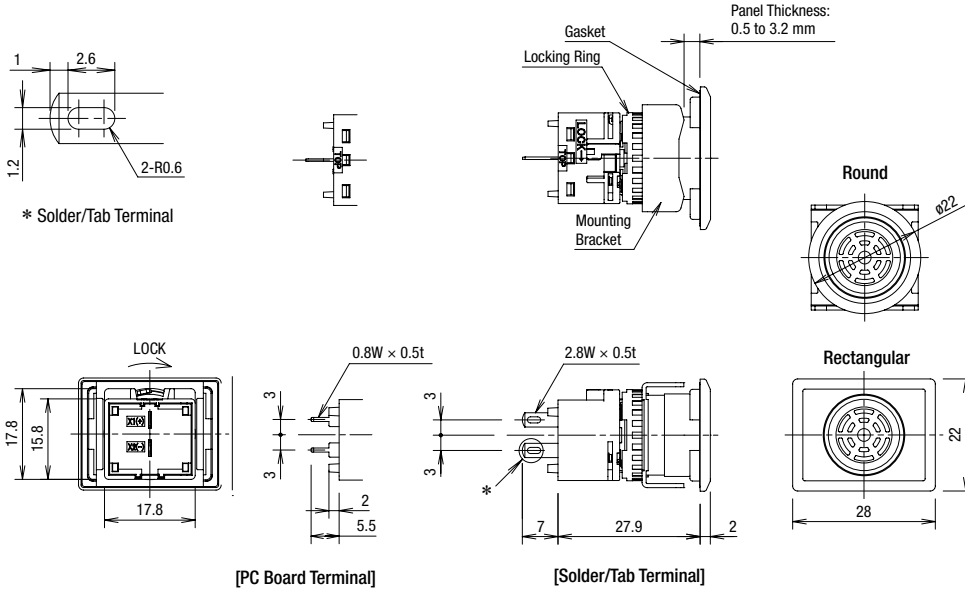

Terminal Arrangement (Bottom View)

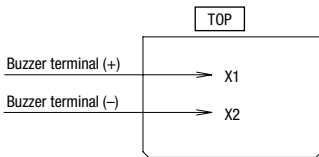

Panel Cut-out for Positioning  
Round (LB6Z/LB6MZ)

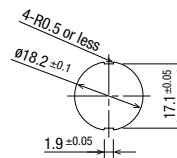

Mounting Hole Layout

Round (LB6Z/LB6MZ)

Rectangular (LB8Z/LB8MZ)

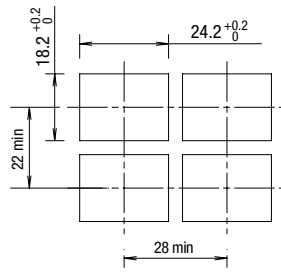
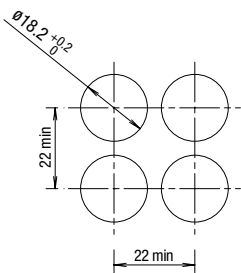

Note: When using rubber boot or terminal cover, see dimensions on B-127 and B-128.

- For details on pc board and circuit design, see B-121.
- For details on single board mounting, see B-122.

# LBW-SERIES | Flush Silhouette Switches

## Flush Silhouette Switches



**Slim**  
Thinnest in the industry  
(as of May 2012)

Projects only 2mm from the panel. Removable contact blocks ideal for single board mounting.  $\varnothing 26/\square 26$  bezel size for easy operation.

point For sleek and refined style

\* Panel cutout (mm)



### Illuminated Pushbuttons

Illuminated pushbuttons with switch guard available



### Ring-illuminated Pushbuttons



### Pushbuttons

Marking plates can be used with lens style pushbuttons



\*Does not light on.



Pushbuttons with switch guard available



### Pilot Lights



### Selector Switches

2-position and 3-position selector switches. Maintained and spring return actions available.



**Key Selectors**  
ensure safety

Wave Key

Seven different keys to choose from. Key removable in desired positions.

### Stylish Appearance with Advanced Functions

Operation status is easily visible due to illumination on the operator.



Illuminated Selector Switch (LB series only)



Switch guard prevents inadvertent switch operation



**Illuminated Pushbutton Color Variations**

R (red) G (green) Y (yellow) A (amber) S (blue) PW (pure white)

**Pushbutton Color Variations**

B (black) G (green) R (red) Y (yellow) S (blue) W (white)

**Bezel Color Variations**

Metallic Black

**Ring-Illuminated Pushbutton Color Variations**

R (red) G (green) A (amber) S (blue) PW (pure white)

**Ring-Illuminated Pushbutton Bezels**

Square Black Round Black Square Metallic Round Metallic

# Flush Silhouette Switches LBW Series

Flush bezel projects only 2 mm from front of panel.

## Contact Ratings

Gold Contact (switch base: blue)

Rated Insulation Voltage		250V	
Rated Thermal Current		3A	
Rated Operating Voltage		30V DC	125V AC
Rated Operating Current (electrical life: 100,000 operations)	Resistive Load	0.1A	0.1A
Contact Material		Gold plated silver	

- Minimum applicable load (reference value): 5V AC/DC, 1 mA  
Applicable range is subject to the operating conditions and load.
- See electrical life in Specifications.

Silver Contact (switch base: gray)

Rated Insulation Voltage		250V				
Rated Operating Voltage		30V	125V	250V		
Rated Operating Current	Electrical Life 50,000 operations	AC 50/60Hz	Resistive load	—	5A	5A
			Inductive load	—	3A	1.5A
		DC	Resistive load	5A	1.1A	—
	Inductive load		2A	0.4A	—	
	Electrical Life 100,000 operations	AC 50/60Hz	Resistive load	—	5A	3A
			Inductive load	—	3A	1.5A
DC		Resistive load	3A	0.6A	—	
	Inductive load	1A	0.22A	—		
Rated Thermal Current		5A				
Contact Material		Silver				

- AC inductive load: PF=0.6 to 0.7 DC inductive load: L/R=7 ms max.

## LED Ratings

Rated Voltage	5V DC	12V AC/DC	24V AC/DC
Voltage Range	5V DC±5%	12V AC/DC±10%	24V AC/DC ±10%
LED Part No.	LB9Z-LED5②	LB9Z-LED1②	LB9Z-LED2②
Current Draw	A, R: 18 mA G, S: 6 mA PW: 5 mA		
Voltage Marking	Marked on the side of the LED unit		
LED Life (reference value)	Approx. 30,000 hours [until the brightness reduces to 50% of the initial value when lit at the rated voltage (direct current) under 25°C environment.]		
Internal Circuit	A, G, R, PW, S		

- ② (color code): A (amber), G (green), PW (pure white), R (red), S (blue)
- Use the pure white (PW) module for yellow illumination.
- LED lamp contains a current-limiting resistor.



## Specifications

Operating Temperature	-25 to +60°C (no freezing) Illuminated units: -25 to +55°C	
Storage Temperature	-30 to +80°C (no freezing)	
Operating Humidity	45 to 85% RH (no condensation)	
Contact Resistance	50 mΩ maximum (initial value)	
Insulation Resistance	100 MΩ minimum (500V DC megger)	
Dielectric Strength	Switch Unit	Between live part and ground: 2,000V AC, 1 minute Between terminals of different poles: 2,000V AC, 1 minute Between terminals of the same poles: 1,000V AC, 1 minute
	Illumination Unit	Between live part and ground: 2,000V AC, 1 minute
Vibration Resistance	Operating extremes/Damage limits: 5 to 55 Hz, amplitude 0.5 mm	
Shock Resistance	Operating extremes: 100 m/s <sup>2</sup> Damage limits: 1,000 m/s <sup>2</sup>	
Mechanical Life (minimum operations)	Momentary: 2,000,000 Maintained: 250,000 Selector switches: 250,000 Key selector switches: 250,000	
Electrical Life (minimum operations)	Momentary: 50,000 / 100,000 (*1) Maintained: 50,000 / 100,000 (*2) Selector switches: 50,000 / 100,000 (*2) Key selector switches: 50,000 / 100,000 (*2)	
Degree of Protection	IP65 (IEC 60529)	
Terminal Style	Solder/tab terminal #110 PC board terminal	
Weight (approx.)	16g (LBW7L-M1T24) 14g (LBW7P-1T04) 15g (LBW7B-M1T2) 17g (LBW7S-2T2) 29g (LBW7K-2ST2A) 17g (LBW7GL-M1T24) 18g (LBW7GB-M1T2)	

\*1: Switching frequency 1,800 operations/h.

\*2: Switching frequency 1,200 operations/h.

APEM

Switches & Pilot Lights

Control Boxes

Emergency Stop Switches

Enabling Switches

Safety Products

Explosion Proof

Terminal Blocks

Relays & Sockets

Circuit Protectors

Power Supplies

LED Illumination

Controllers

Operator Interfaces

Sensors

AUTO-ID

Flush Silhouette

ø16

ø22

ø30

Miniature

Pilot Lights

CW

LW-F

LB

LBW

UP

Flush Bezel



Download catalogs and CAD from <http://eu.idec.com/downloads>

## Illuminated Pushbuttons

Solder/Tab Terminal

Package Quantity:1

① Shape	② Operation	④ Contact	⑤ LED Operating Voltage	Part No.	* Illumination Color Code
Black bezel	Momentary	Gold/SPDT	24V AC/DC	LBW $\odot$ L-M $\odot$ T14*	Specify the color code in place of * in the Part No.  A: amber G: green PW: pure white R: red S: blue Y: yellow
		Gold/DPDT		LBW $\odot$ L-M $\odot$ T24*	
	Maintained	Gold/SPDT	24V AC/DC	LBW $\odot$ L-A $\odot$ T14*	
		Gold/DPDT		LBW $\odot$ L-A $\odot$ T24*	
Metallic bezel	Momentary	Gold/SPDT	24V AC/DC	LBW $\odot$ L-M $\odot$ T14*	
		Gold/DPDT		LBW $\odot$ L-M $\odot$ T24*	
	Maintained	Gold/SPDT	24V AC/DC	LBW $\odot$ L-A $\odot$ T14*	
		Gold/DPDT		LBW $\odot$ L-A $\odot$ T24*	
Guard Type	Momentary	Gold/SPDT	24V AC/DC	LBW $\odot$ L-M $\odot$ T14*	
		Gold/DPDT		LBW $\odot$ L-M $\odot$ T24*	
	Maintained	Gold/SPDT	24V AC/DC	LBW $\odot$ L-A $\odot$ T14*	
		Gold/DPDT		LBW $\odot$ L-A $\odot$ T24*	

- Flush/Extended color code: A (amber), G (green), PW (pure white), R (red), S (blue), Y (yellow)
- Ring-illuminated color code: PW (pure white), W (white), WA (amber), WG (green), WR (red), WS (blue)
- Illuminated pushbuttons contain an LED unit. For details on LED units, see **B-130**.
- The guard opens 180 degrees spring-return.
- Illuminated pushbuttons can be used with legend markings. Engraving can be done on a marking plate which is placed in the lens, or a clear film can be printed and placed in the lens. See **B-134** for details on the marking plate and film.
- White lens type (when light is off) are available. Clear lens is used instead of colored lens for amber, green, red, and blue illuminated pushbuttons. Amber, green, red, or blue LED units are used. To specify, see Part Number Development below.
- PC board terminals available for gold contacts. Silver contacts also available. To specify, see Part Number Development below.
- Extended pushbuttons available. To specify, see Part Number Development below. Pushbuttons with guard is not available. Extended pushbutton is available with momentary operation only.
- Flush ring-illuminated style is available. See Part Number Development below (③). Guard is not available with flush ring-illuminated style.
- 5V DC and 12V AC/DC LED operating voltages also available.
- Other bezel sizes available (LB series). For details, see **B-075**.

## Part Number Development

LBW $\odot$ L-②③T④⑤⑥\*

## ① Shape

Code	Shape
6	Round / Black Bezel
7	Square / Black Bezel
6M	Round / Metallic Bezel
7M	Square / Metallic Bezel
6G	Round with Guard
7G	Square with Guard

## ② Operation

Code	Operation
A	Maintained
M	Momentary

## ③ Operator Style

Code	Operator Style
1	Flush
2	Extended
1R	Flush Ring-illuminated

- Extended style is available only for round (black/metallic bezel) and in momentary operation.
- Guard model is not available for Flush Ring-illuminated types. Also, Y (yellow) is not available.

## ④ Contacts

Code	Contact
1	Gold/SPDT
2	Gold/DPDT
5	Silver/SPDT
6	Silver/DPDT

## ⑤ LED Operating Voltage

Code	Rated Operating Voltage
1	5V DC
3	12V AC/DC
4	24V AC/DC

## ⑥ Others

Code	Specification	Part No. Example
Blank	Solder/Tab Terminal	—
V	PC Board Terminal (Gold Contact Only)	LBW6L-M1T14V*

- Specify the color code in place of \* in the table above.

APEM

Switches & Pilot Lights

Control Boxes

Emergency Stop Switches

Enabling Switches

Safety Products

Explosion Proof

Terminal Blocks

Relays & Sockets

Circuit Protectors

Power Supplies

LED Illumination

Controllers

Operator Interfaces

Sensors

AUTO-ID

Flush Silhouette

ø16

ø22

ø30

Miniature

Pilot Lights

CW

LW-F

LB

LBW

UP

Flush Bezel

Dimensions

All dimensions in mm.

Flush/Ring-illuminated

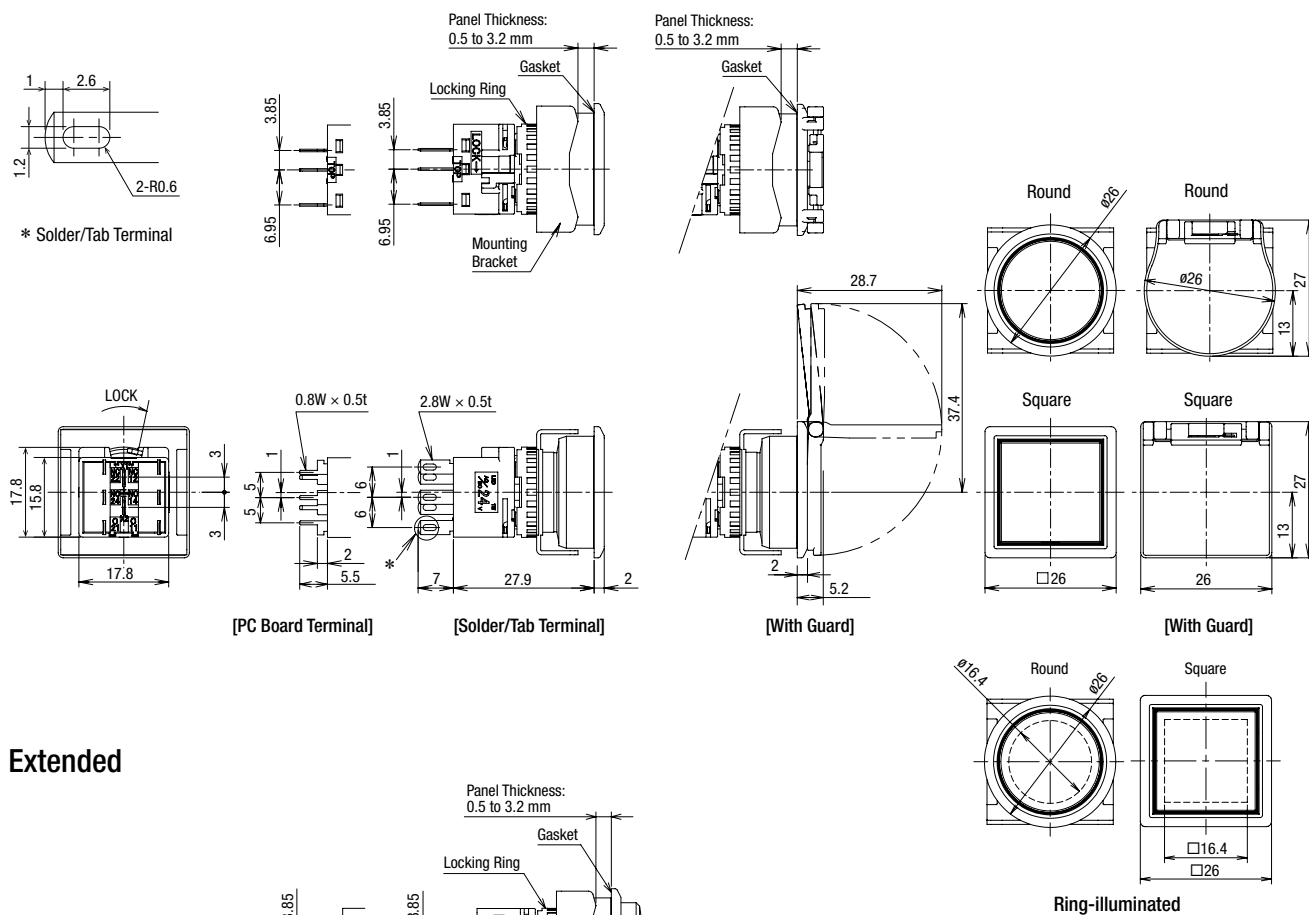

Extended

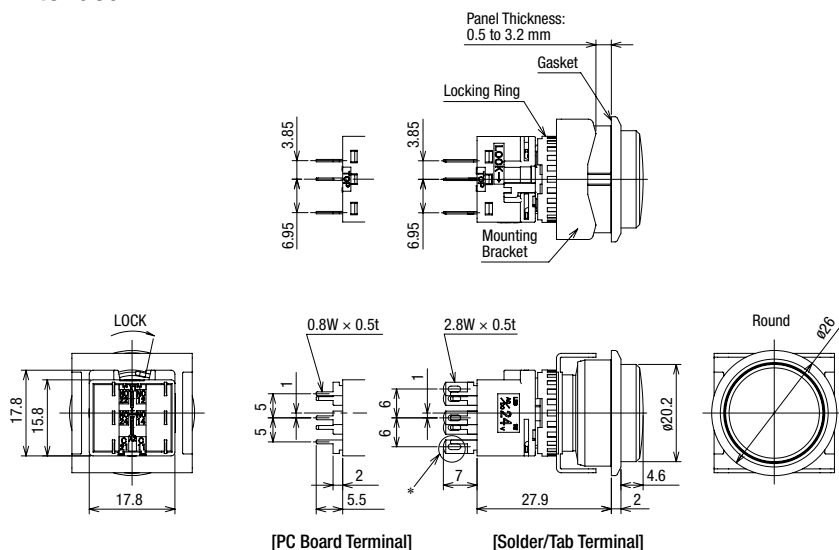

Terminal Arrangement (Bottom View)

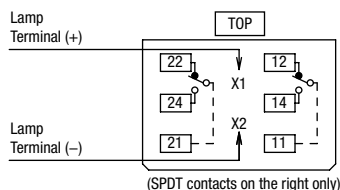

- For details on pc board and circuit design, see B-121.
- For details on single board mounting, see B-122.

Mounting Hole Layout

Round (LBW6/LBW6M)

Square (LBW7/LBW7M)

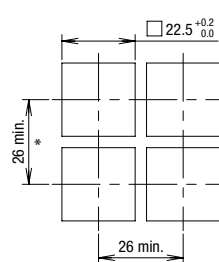
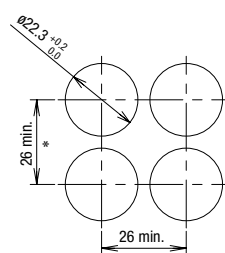

\*: 53 mm minimum for switches with guard.







Download catalogs and CAD from <http://eu.idec.com/downloads>



## Pilot Lights

Package Quantity:1

## Solder/Tab Terminal

Part No. / Shape	LBW①P-1T0②③*			
	 Round / Black Bezel	 Square / Black Bezel	 Round / Metallic Bezel	 Square / Metallic Bezel
① Shape	③ LED Operating Voltage	Part No.	* Illumination Color Code	
Black Bezel	24V AC/DC	LBW③P-1T04*	Specify the color code in place of * in the Part No. A: amber G: green PW: pure white R: red S: blue Y: yellow	
Metallic Bezel	24V AC/DC	LBW③P-1T04*		

- Pilot lights contain an LED unit. For maintenance LED units see **B-130**.
- Legends and symbols can be engraved on a marking plate or film to be inserted under the lens by users for labelling purposes. See **B-134** for details.
- White lens type (when light is off) are available. Clear lens is used instead of colored lens for amber, green, red, and blue pilot lights. Amber, green, red, or blue LED units are used. To specify, see Part Number Development below.
- PC board terminals available. To specify, see Part Number Development below.
- 5V DC and 12V AC/DC LED operating voltages also available.
- Other bezel sizes available (LB series). For details, see **B-077**.

## Part Number Development

## LBW①P-1T0②③\*

## ① Shape

Code	Shape
6	Round / Black Bezel
7	Square / Black Bezel
6M	Round / Metallic Bezel
7M	Square / Metallic Bezel

## ② LED Operating Voltage

Code	Rated Operating Voltage
1	5V DC
3	12V AC/DC
4	24V AC/DC

## ③ Others

Code	Specification	Part No. Example
Blank	Solder/Tab Terminal	—
V	PC Board Terminal	LBW6P-1T04V*

- Specify the color code in place of \* in the table above.

- APEM
- Switches & Pilot Lights
- Control Boxes
- Emergency Stop Switches
- Enabling Switches
- Safety Products
- Explosion Proof
- Terminal Blocks
- Relays & Sockets
- Circuit Protectors
- Power Supplies
- LED Illumination
- Controllers
- Operator Interfaces
- Sensors
- AUTO-ID

- Flush Silhouette
- ø16
- ø22
- ø30
- Miniature
- Pilot Lights

- CW
- LW-F
- LB
- LBW
- UP
- Flush Bezel

Dimensions

All dimensions in mm.

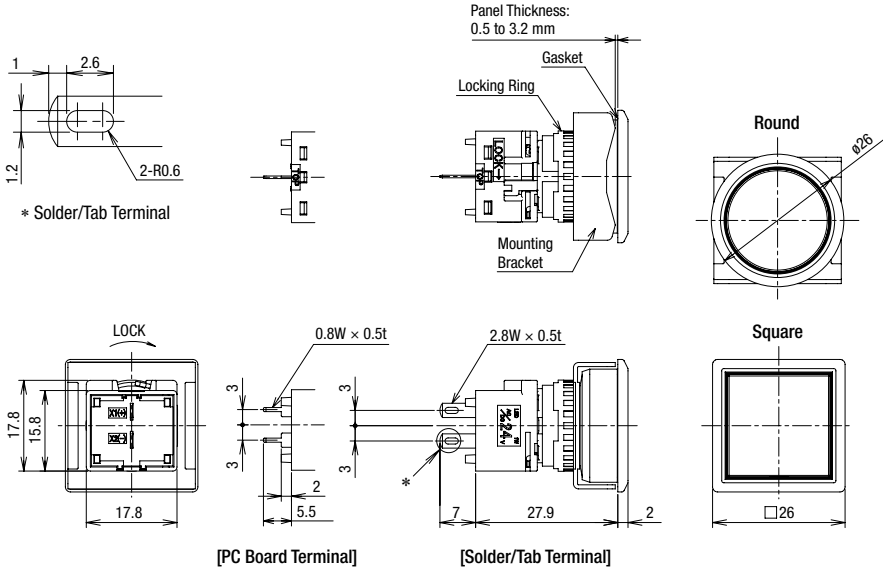

Terminal Arrangement (Bottom View)

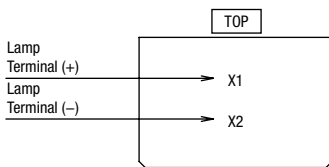

Panel Cut-out for Positioning

Round (LBW6P/LBW6MP)

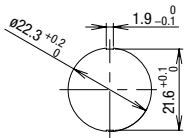

Mounting Hole Layout

Round (LBW6P/LBW6MP)

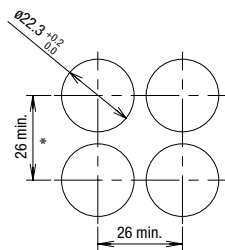

Square (LBW7P/LBW7MP)

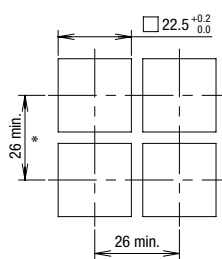

- For details on pc board and circuit design, see B-121.
- For details on single board mounting, see B-122.

## Pushbuttons

Package Quantity:1

## Solder/Tab Terminal

Part No. / Shape **LBW①B-②1T③④\***

Flush



Round / Black Bezel



Square / Black Bezel



Round / Metallic Bezel



Square / Metallic Bezel



Round with Guard



Square with Guard

Extended

Round only  
(metallic bezel available)

① Shape	Button Style	② Operation	③ Contact	Part No.		* Illumination Color Code
				Gold Contact	Silver Contact	
Black bezel	Button	Momentary	SPDT	LBW①B-M1T1*	LBW①B-M1T5*	Specify the color code in place of * in the Part No.  B: black G: green R: red S: blue W: white Y: yellow
			DPDT	LBW①B-M1T2*	LBW①B-M1T6*	
			3PDT	LBW①B-M1T3*	LBW①B-M1T7*	
		Maintained	SPDT	LBW①B-A1T1*	LBW①B-A1T5*	
			DPDT	LBW①B-A1T2*	LBW①B-A1T6*	
			3PDT	LBW①B-A1T3*	LBW①B-A1T7*	
Metallic bezel	Button	Momentary	SPDT	LBW①B-M1T1*	LBW①B-M1T5*	
			DPDT	LBW①B-M1T2*	LBW①B-M1T6*	
			3PDT	LBW①B-M1T3*	LBW①B-M1T7*	
		Maintained	SPDT	LBW①B-A1T1*	LBW①B-A1T5*	
			DPDT	LBW①B-A1T2*	LBW①B-A1T6*	
			3PDT	LBW①B-A1T3*	LBW①B-A1T7*	
Guard Type	Button	Momentary	SPDT	LBW①B-M1T1*	LBW①B-M1T5*	
			DPDT	LBW①B-M1T2*	LBW①B-M1T6*	
			3PDT	LBW①B-M1T3*	LBW①B-M1T6*	
		Maintained	SPDT	LBW①B-A1T1*	LBW①B-A1T5*	
			DPDT	LBW①B-A1T2*	LBW①B-A1T6*	
			3PDT	LBW①B-A1T3*	LBW①B-A1T7*	

- The guard opens 180 degrees spring-return.
- PC board terminals available for gold contacts. To specify, see Part Number Development below.
- Pushbuttons can be used with legend markings engraved on marking plates and lens buttons with clear film inserted in the lens is available. To specify, see Part Number Development below. See **B-134** for details on the marking plate and film.
- Extended pushbuttons available. To specify, see Part Number Development below. Pushbuttons with guard is not available. Extended pushbutton is available with momentary operation only.
- Other bezel sizes available (LB series). For details, see **B-079**.

## Part Number Development

LBW①B-②③1T④⑤\*

## ① Shape

Code	Shape
6	Round / Black Bezel
7	Square / Black Bezel
6M	Round / Metallic Bezel
7M	Square / Metallic Bezel
6G	Round with Guard
7G	Square with Guard

## ② Operation

Code	Operation
A	Maintained
M	Momentary

## ③ Operator Style

Code	Operation
1	Flush
2	Extended *

\* Extended style is available only for round (black/metallic bezel) and in momentary operation. Guard model is not available.

## ④ Contacts

Code	Contact	Code	Contact
1	Gold/SPDT	5	Silver/SPDT
2	Gold/DPDT	6	Silver/DPDT
3	Gold/3PDT	7	Silver/3PDT

## ⑤ Others

Code	Specification	Part No. Example
Blank	Solder/Tab Terminal	—
L (Note 1)	Lens	LBW6B-M1T1L*
V	PC Board Terminal (Gold Contact Only)	LB6WB-M1T1V*
VL (Note 1)	PC Board Terminal with Lens (Gold Contact Only)	LB6WB-M1T1VL*

Note 1: Codes L and VL are available with flush operator only.

- Color code (\*) for lens:  
A (amber), B (translucent lens with black nameplate), G (green), R (red), S (blue), W (white), Y (yellow)

Dimensions

All dimensions in mm.

Flush Pushbutton

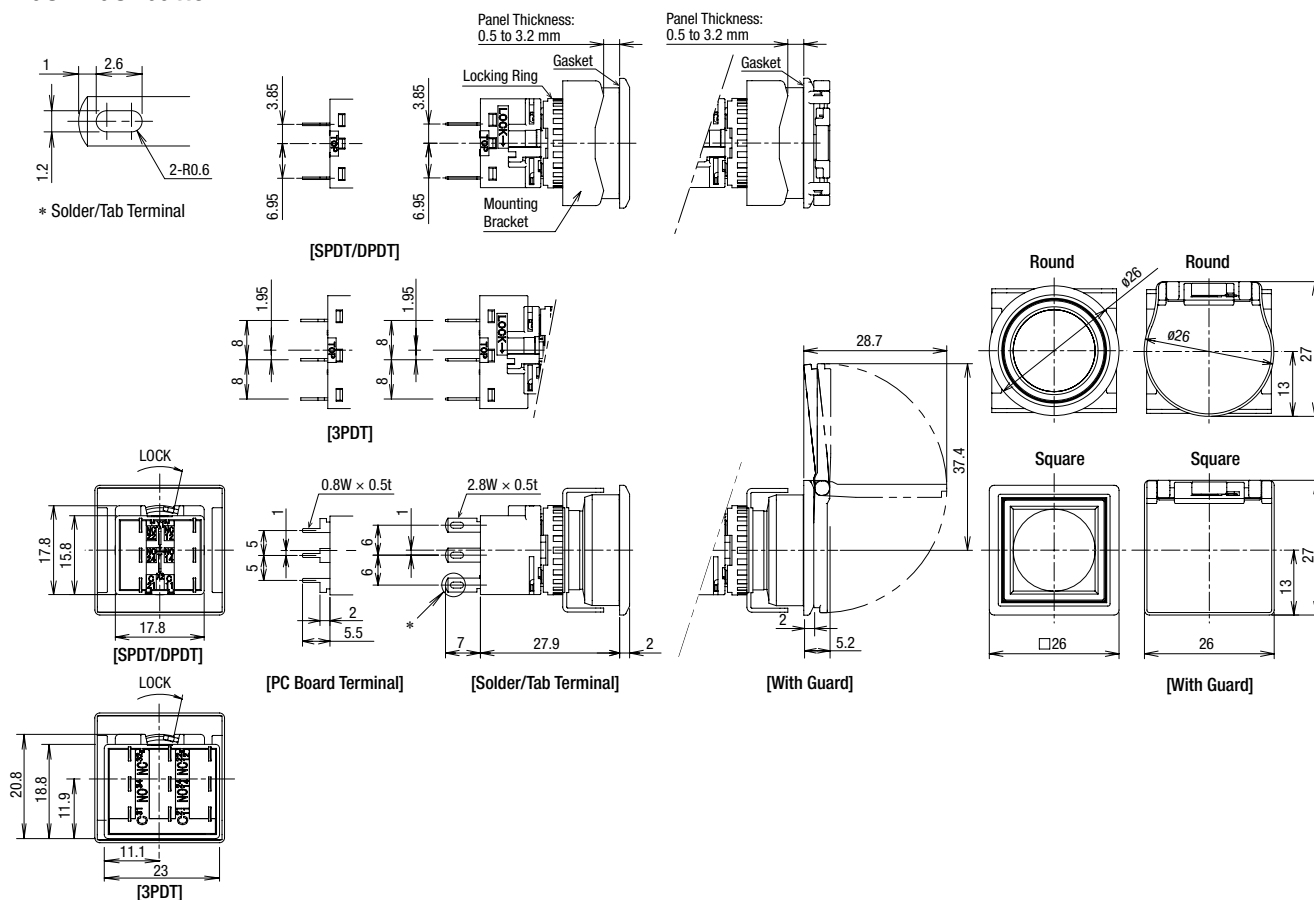

Extended Pushbutton

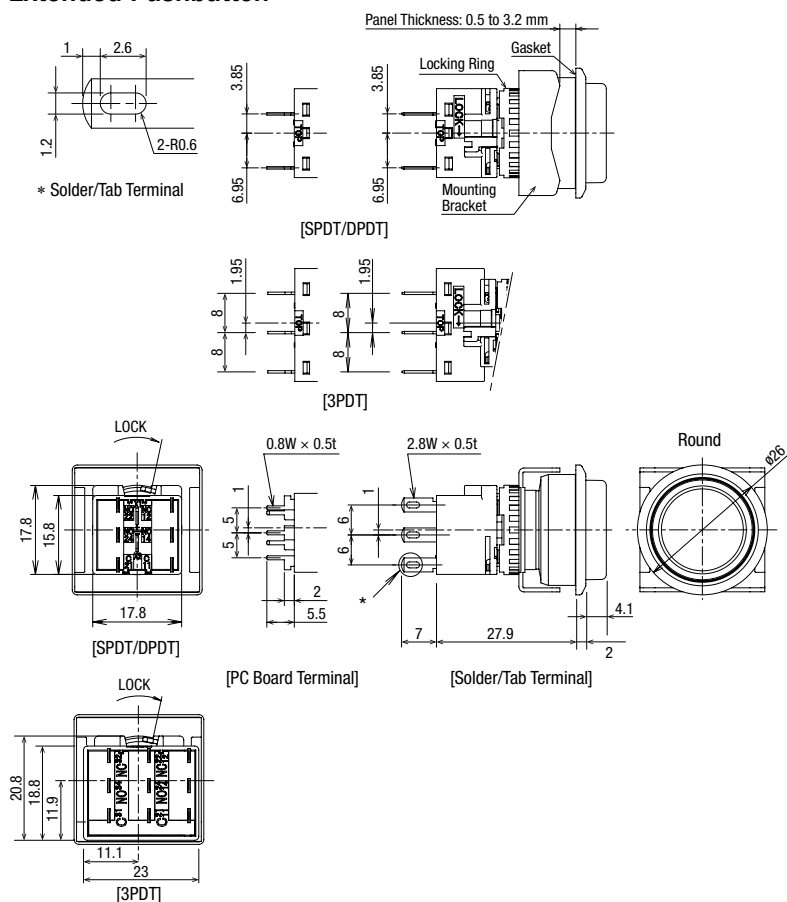

Terminal Arrangement (Bottom View)

SPDT/DPDT Contacts

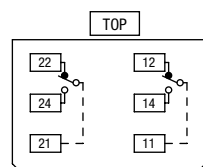

(SPDT contacts on the right only)

3PDT Contacts

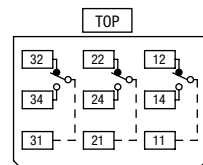

- For details on mounting hole layout, see B-120.
- For details on pc board and circuit design, see B-121.
- For details on single board mounting, see B-122.

APEM

Switches & Pilot Lights

Control Boxes

Emergency Stop Switches

Enabling Switches

Safety Products

Explosion Proof

Terminal Blocks

Relays & Sockets

Circuit Protectors

Power Supplies

LED Illumination

Controllers

Operator Interfaces

Sensors

AUTO-ID

Flush Silhouette

ø16

ø22

ø30

Miniature

Pilot Lights

CW

LW-F

LB

LBW

UP

Flush Bezel



Download catalogs and CAD from <http://eu.idec.com/downloads>

## Selector Switches

Solder/Tab Terminal

Package Quantity:1

① Shape	② Operator Position		③ Contact	Part No.	
				Gold Contact	Silver Contact
Black bezel	90° 2-position	Maintained	SPDT	LBW①S-2T1	LBW①S-2T5
			DPDT	LBW①S-2T2	LBW①S-2T6
			3PDT	LBW①S-2T3	LBW①S-2T7
	45° 3-position	Maintained	DPDT	LBW①S-3T2	LBW①S-3T6
			3PDT	LBW①S-3T3	LBW①S-3T7
		Spring return two-way	DPDT	LBW①S-33T2	LBW①S-33T6
Metallic bezel	90° 2-position	Maintained	SPDT	LBW①S-2T1	LBW①S-2T5
			DPDT	LBW①S-2T2	LBW①S-2T6
			3PDT	LBW①S-2T3	LBW①S-2T7
	45° 3-position	Maintained	DPDT	LBW①S-3T2	LBW①S-3T6
			3PDT	LBW①S-3T3	LBW①S-3T7
		Spring return two-way	DPDT	LBW①S-33T2	LBW①S-33T6
		DPDT	LBW①S-33T3	LBW①S-33T7	

• PC board terminals available for gold contacts. To specify, see Part Number Development below.

• For contact operation, see **B-119**.

• Other bezel sizes available (LB series). For details, see **B-081**.

## Part Number Development

## LBW ① S - ② T ③ ④

## ① Shape



Code	Shape
6	Round / Black Bezel
7	Square / Black Bezel
6M	Round / Metallic Bezel
7M	Square / Metallic Bezel

## ② Operator Position

## 2-position

Operator Position
2 Maintained

## 3-position

Operator Position	
3 Maintained	33 Spring return two-way
	

## ③ Contacts

Code	Contact
1	Gold/SPDT (90° 2-position only)
2	Gold/DPDT
3	Gold/3PDT
5	Silver/SPDT (90° 2-position only)
6	Silver/DPDT
7	Silver/3PDT

## ④ Others

Code	Specification	Part No. Example
Blank	Solder/Tab Terminal	—
V	PC Board Terminal (Gold Contact Only)	LBW6S-2T1V

Dimensions

All dimensions in mm.

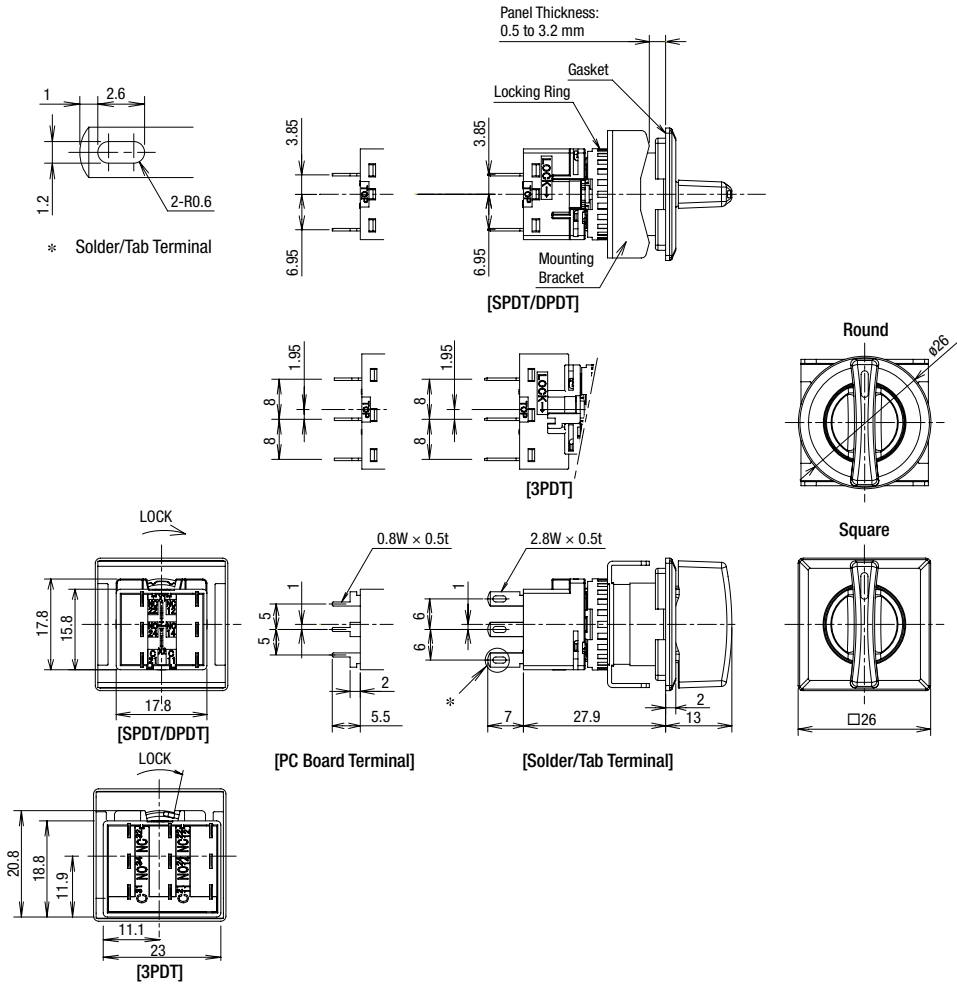

Terminal Arrangement (Bottom View)

SPDT/DPDT Contacts

3PDT Contacts

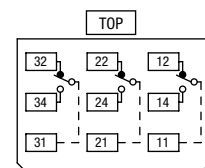
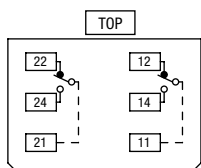

Panel Cut-out for Positioning

Round (LBW6S/LBW6MS)

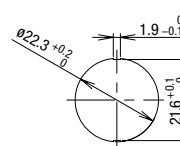

Mounting Hole Layout

Round (LBW6S/LBW6MS)

Square (LBW7S/LBW7MS)

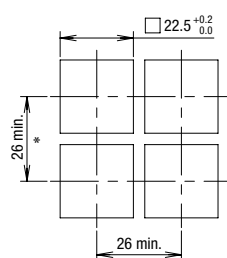
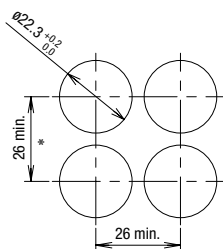

- For details on pc board and circuit design, see **B-121**.
- For details on single board mounting, see **B-122**.

APEM

Switches & Pilot Lights

Control Boxes

Emergency Stop Switches

Enabling Switches

Safety Products

Explosion Proof

Terminal Blocks

Relays & Sockets

Circuit Protectors

Power Supplies

LED Illumination

Controllers

Operator Interfaces

Sensors

AUTO-ID

Flush Silhouette

ø16

ø22

ø30

Miniature

Pilot Lights

CW

LW-F

LB

LBW











UP

Flush Bezel

## Key Selector Switches

## Solder/Tab Terminal

Package Quantity:1

Part No. / Shape	LBW ① K - ② ③ T ④ ⑤ - ⑥					
	Wave Key			Disc Tumbler Key		
						
	Round / Black Bezel	Square / Black Bezel	Round / Metallic Bezel	Square / Metallic Bezel	Round / Metallic Bezel	Square / Metallic Bezel
① Shape	② Operator Position		⑤ Key Removable Position	⑤ Contact	Part No.	
					Gold Contact	Silver Contact
Black bezel	90° 2-position	Maintained	A: Key removable in all positions 	SPDT	LBW⊙K-2ST1A	LBW⊙K-2ST5A
				DPDT	LBW⊙K-2ST2A	LBW⊙K-2ST6A
				3PDT	LBW⊙K-2ST3A	LBW⊙K-2ST7A
	45° 3-position	Maintained	A: Key removable in all positions 	DPDT	LBW⊙K-3ST2A	LBW⊙K-3ST6A
3PDT				LBW⊙K-3ST3A	LBW⊙K-3ST7A	
Metallic bezel	90° 2-position	Maintained	A: Key removable in all positions 	SPDT	LBW⊙K-2ST1A	LBW⊙K-2ST5A
				DPDT	LBW⊙K-2ST2A	LBW⊙K-2ST6A
				3PDT	LBW⊙K-2ST3A	LBW⊙K-2ST7A
	45° 3-position	Maintained	A: Key removable in all positions 	DPDT	LBW⊙K-3ST2A	LBW⊙K-3ST6A
3PDT				LBW⊙K-3ST3A	LBW⊙K-3ST7A	

- For operator position, see Part Number Development below.
- For key removable position, see Part Number Development below. The key cannot be removed at the return position.
- Two keys are supplied.
- Besides the standard key (key number 0H), six other keys are available.
- Disc tumbler keys also available. Only the standard key is available. To specify, see Part Number Development below.
- PC board terminals available for gold contacts. To specify, see Part Number Development below.
- For contact operation, see **B-119**.
- Other bezel sizes available (LB series). For details, see **B-085**.

## Part Number Development

## LBW ① K - ② ③ T ④ ⑤ - ⑥

## ① Shape

Code	Shape
6	Round / Black Bezel
7	Square / Black Bezel
6M	Round / Metallic Bezel
7M	Square / Metallic Bezel

## ② Operator Position

Code	Operator Position
2	90° 2-position maintained
3	45° 3-position maintained
33	45°-3-position spring return two-way

## ③ Key Style

Code	Key Style
S	Wave key
Blank	Disc tumbler key



## ④ Contacts

Code	Contact
1	Gold/SPDT (90° 2-position only)
2	Gold/DPDT
3	Gold/3PDT
5	Silver/SPDT (90° 2-position only)
6	Silver/DPDT
7	Silver/3PDT



## ⑤ Key Removal Position

The key cannot be removed at the return position.

## 2-position

Key Removable Position	
A: Key removable in all positions 	B: Key removable at left 

## 3-position

Key Removable Position	
A: Key removable in all positions 	D: Key removable at center 

## 3-position

Spring return two-way

- Key is removable at ⊙, ⊙, ⊙.
- Key is retained at ●, ●, and ●.

## ⑥ Key Number

Code	Key Number
0H	Standard key
1H to 2H	Reversible key
3H to 6H	Non-reversible key

- Wave keys only.

## Others

Code	Specification	Part No. Example
Blank	Solder/Tab Terminal	—
V	PC Board Terminal (Gold Contact Only)	LBW6K-2T1VA

APEM
Switches & Pilot Lights
Control Boxes
Emergency Stop Switches
Enabling Switches
Safety Products
Explosion Proof
Terminal Blocks
Relays & Sockets
Circuit Protectors
Power Supplies
LED Illumination
Controllers
Operator Interfaces
Sensors
AUTO-ID

Flush Silhouette
ø16
ø22
ø30
Miniature
Pilot Lights
CW
LW-F
LB
<b>LBW</b>
UP
Flush Bezel

Dimensions

All dimensions in mm.

Key Selector Switches with Wave Key

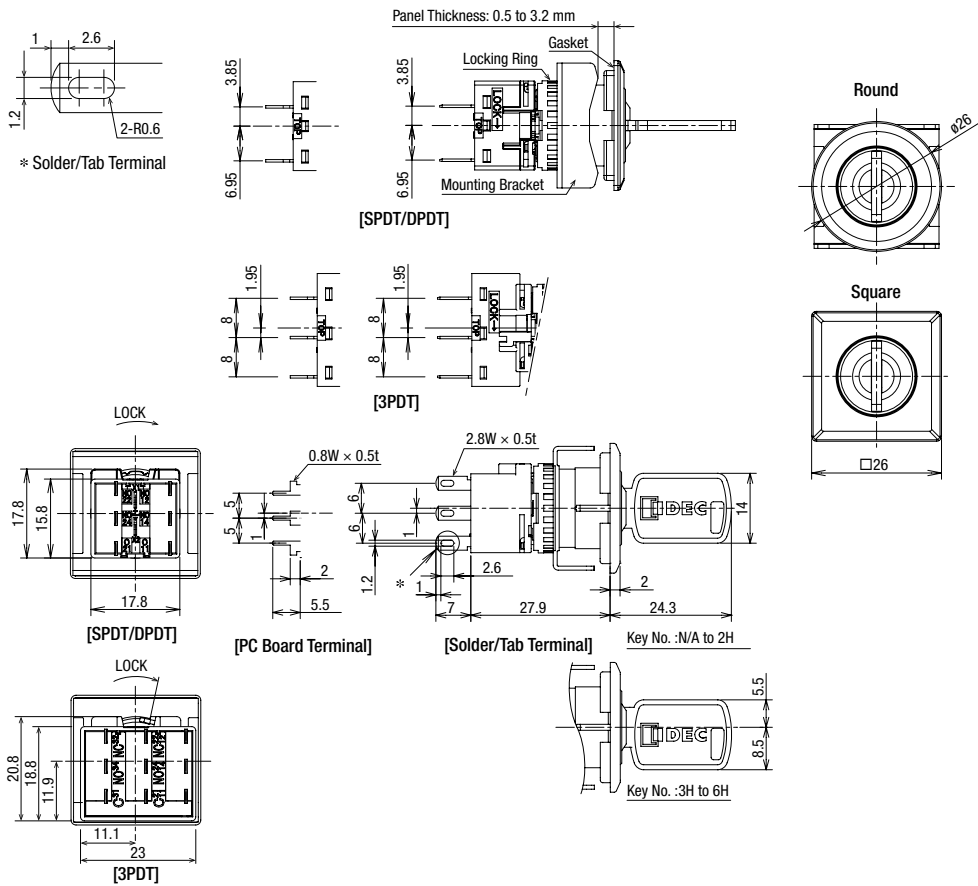

Key Selector Switches with Disc Tumbler Key

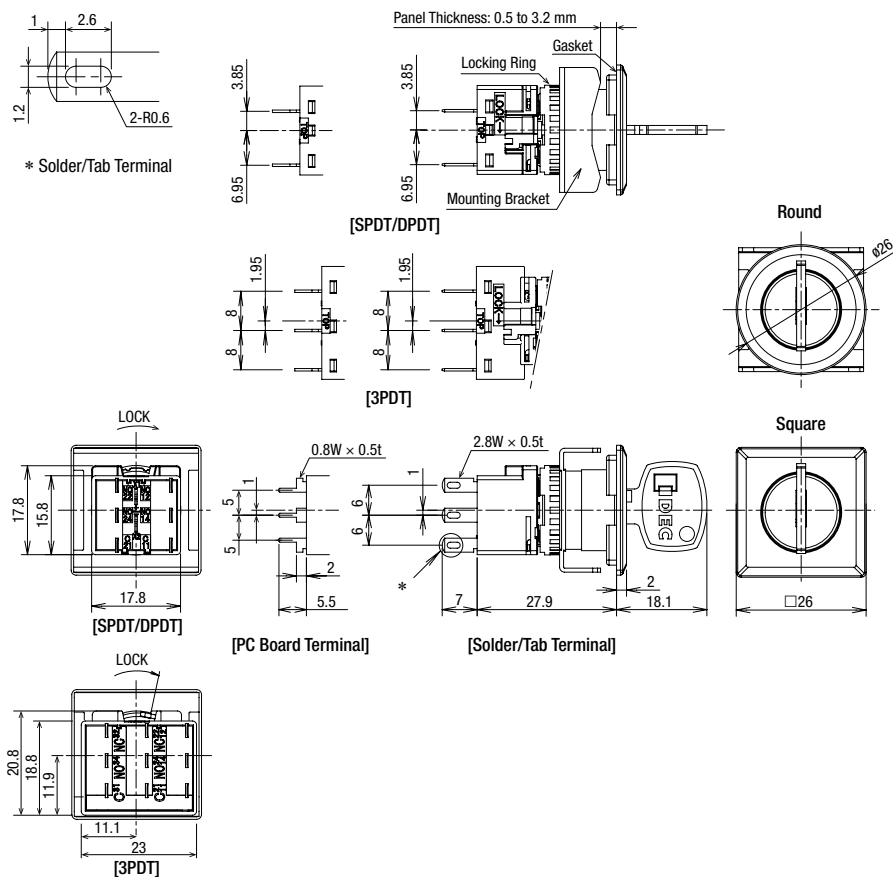

Terminal Arrangement (Bottom View)

SPDT/DPDT Contacts

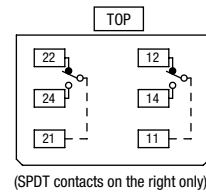

3PDT Contacts

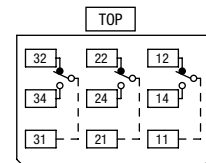

- For details on mounting hole layout, see **B-120**.
- For details on pc board and circuit design, see **B-121**.
- For details on single board mounting, see **B-122**.



# Ø16 LB-SERIES

## Miniature Switches and Pilot Lights (Standard Bezel)

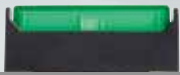

**Short**  
Shortest in the industry  
(as of February 2011)

Panel depth of only 27.9mm.  
Removable contact blocks ideal for single board mounting.  
Protection degree: IP65 (IEC 60529)

**point** For space-saving installation

\* Panel cutout (mm)



Actual Size  
**27.9mm**

Round  
Ø16.2\*

Square  
□16.2\*

Rectangular  
16.2×24\*



### Illuminated Pushbuttons



### Pushbuttons

Marking plates can be used with lens style pushbuttons



\*Does not light on.



### Pilot Lights



### Dome Pilot Lights



### Selector Switches

2- and 3-position selector switches. Maintained and other various spring return actions available.

\*Photo: knob operator (lever operator also available)

Illuminated selector switches available



**Key Selectors**  
ensure safety

Wave Key

Seven different keys to choose from. Key removable in desired positions.



### Buzzers

Steady sound at 80 dB minimum (at 0.1m)  
IP54 tab terminals, PC board terminal, and IP40 solder terminals available.



### Lever Switches

Degree of protection: IP67  
Up/down operation.  
2- and 3-positions available.  
For 3-position switches, maintained and return two-way actions available.



Illuminated Pushbutton Color Variations



Pushbutton Color Variations



# ø16mm LB Series Switches and Pilot Lights

Panel depth of only 27.9mm.

Removable contact blocks ideal for single board mounting.

## Contact Ratings

Gold Contact (switch base: blue)

Rated Insulation Voltage		250V	
Rated Thermal Current		3A	
Rated Operating Voltage		30V DC	125V AC
Rated Operating Current (electrical life: 100,000 operations)	Resistive Load	0.1A	0.1A
Contact Material		Gold plated silver	

- Minimum applicable load (reference value): 5V AC/DC, 1 mA  
Applicable range is subject to the operating conditions and load.
- See electrical life in Specifications.

Silver Contact (switch base: gray)

Rated Insulation Voltage		250V				
Rated Operating Voltage		30V	125V	250V		
Rated Operating Current	Electrical Life 50,000 operations	AC 50/60Hz	Resistive load	—	5A	5A
			Inductive load	—	3A	1.5A
		DC	Resistive load	5A	1.1A	—
	Inductive load		2A	0.4A	—	
	Electrical Life 100,000 operations	AC 50/60Hz	Resistive load	—	5A	3A
			Inductive load	—	3A	1.5A
DC		Resistive load	3A	0.6A	—	
	Inductive load	1A	0.22A	—		
Rated Thermal Current		5A				
Contact Material		Silver				

- AC inductive load: PF=0.6 to 0.7 DC inductive load: L/R=7 ms max.

## LED Ratings

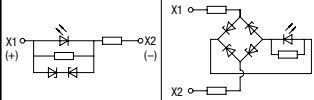
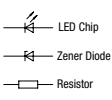
Rated Voltage	5V DC	12V AC/DC	24V AC/DC
Voltage Range	5V DC±5%	12V AC/DC±10%	24V AC/DC ±10%
LED Part No.	LB9Z-LED5②	LB9Z-LED1②	LB9Z-LED2②
Current Draw	A, R: 18 mA G, S: 6 mA PW: 5 mA		
Voltage Marking	Marked on the side of the LED unit		
LED Life (reference value)	Approx. 30,000 hours [until the brightness reduces to 50% of the initial value when lit at the rated voltage (direct current) under 25°C environment.]		
Internal Circuit	A, G, R, PW, S, W		
			

- ② (color code): A (amber), G (green), PW (pure white), R (red), S (blue)
- Use the pure white (PW) module for yellow illumination.
- LED lamp contains a current-limiting resistor.



## Specifications

Operating Temperature	-25 to +60°C (no freezing) Illuminated units: -25 to +55°C	
Storage Temperature	-30 to +80°C (no freezing)	
Operating Humidity	45 to 85% RH (no condensation)	
Contact Resistance	50 mΩ maximum (initial value)	
Insulation Resistance	100 MΩ minimum (500V DC megger)	
Dielectric Strength	Switch Unit	Between live part and ground: 2,000V AC, 1 minute Between terminals of different poles: 2,000V AC, 1 minute Between terminals of the same poles: 1,000V AC, 1 minute
	Illumination Unit	Between live part and ground: 2,000V AC, 1 minute
Vibration Resistance	Operating extremes/Damage limits: 5 to 55 Hz, amplitude 0.5 mm	
Shock Resistance	Operating extremes: 100 m/s <sup>2</sup> Damage limits: 1,000 m/s <sup>2</sup>	
Mechanical Life (minimum operations)	Momentary: 2,000,000 Maintained: 250,000 Selector switches: 250,000 Key selector switches: 250,000	
Electrical Life (minimum operations)	Momentary: 50,000 / 100,000 (*1) Maintained: 50,000 / 100,000 (*2) Selector switches: 50,000 / 100,000 (*2) Key selector switches: 50,000 / 100,000 (*2)	
Degree of Protection	IP65 (IEC 60529)	
Terminal Style	Solder/tab terminal #110 PC board terminal	
Weight (approx.)	11g (LB3L-M1T24) 10g (LB3P-1T04) 10g (LB3B-M1T2) 12g (LB3S-2T2) 25g (LB3K-2ST2A)	

\*1: Switching frequency 1,800 operations/h.

\*2: Switching frequency 1,200 operations/h.

APEM

Switches & Pilot Lights

Control Boxes

Emergency Stop Switches

Enabling Switches

Safety Products

Explosion Proof

Terminal Blocks

Relays & Sockets

Circuit Protectors

Power Supplies

LED Illumination

Controllers

Operator Interfaces

Sensors

AUTO-ID

Flush Silhouette

ø16

ø22

ø30

Miniature

Pilot Lights

LB

A6



Download catalogs and CAD from <http://eu.idec.com/downloads>

## Illuminated Pushbuttons

Solder/Tab Terminal

Package Quantity:1

② Operation	③ Contact	④ LED Operating Voltage	Part No.		* Illumination Color Code
			Gold Contact	Silver Contact	
Momentary	SPDT	24V AC/DC	LB⓪L-M1T14*	LB⓪L-M1T54*	Specify the color code in place of * in the Part No.  A: amber G: green PW: pure white R: red S: blue Y: yellow
	DPDT		LB⓪L-M1T24*	LB⓪L-M1T64*	
Maintained	SPDT	24V AC/DC	LB⓪L-A1T14*	LB⓪L-A1T54*	
	DPDT		LB⓪L-A1T24*	LB⓪L-A1T64*	

- Illuminated pushbuttons contain an LED unit. For details on LED units, see **B-130**.
- Illuminated pushbuttons can be used with legend markings. Engraving can be done on a marking plate which is placed in the lens, or a clear film can be printed and placed in the lens. See **B-133** for details on the marking plate and film.
- PC board terminals available for gold contacts. To specify, see Part Number Development below.
- 5V DC and 12V AC/DC LED operating voltages also available. To specify, see Part Number Development below.

## Part Number Development

LB①L-②1T③④⑤\*

## ① Shape

Code	Shape
1	Round
2	Square
3	Rectangular
4	Rectangular with 3-sided Barrier

## ② Operation

Code	Operation
A	Maintained
M	Momentary

## ③ Contacts

Code	Contact
1	Gold/SPDT
2	Gold/DPDT
5	Silver/SPDT
6	Silver/DPDT

## ④ LED Operating Voltage

Code	Rated Operating Voltage
1	5V DC
3	12V AC/DC
4	24V AC/DC

## ⑤ Others

Code	Specification	Part No. Example
Blank	Solder/Tab Terminal	—
V	PC Board Terminal (Gold Contact Only)	LB1L-M1T14V*

- Specify the color code in place of \* in the table above

- APEM
- Switches & Pilot Lights
- Control Boxes
- Emergency Stop Switches
- Enabling Switches
- Safety Products
- Explosion Proof
- Terminal Blocks
- Relays & Sockets
- Circuit Protectors
- Power Supplies
- LED Illumination
- Controllers
- Operator Interfaces
- Sensors
- AUTO-ID

- Flush Silhouette
- ø16
- ø22
- ø30
- Miniature
- Pilot Lights

- LB
- A6

Dimensions

All dimensions in mm.

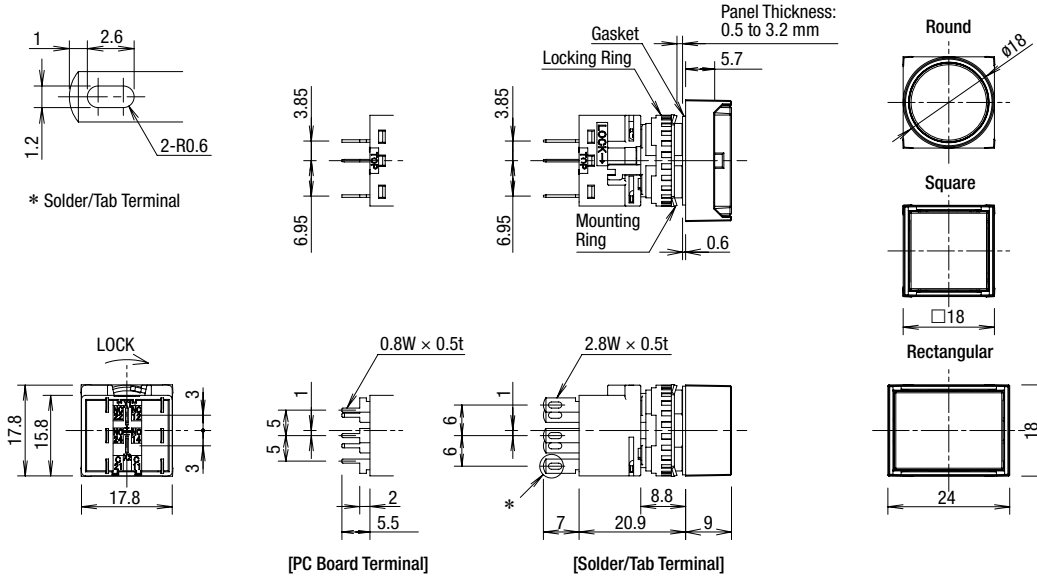

Terminal Arrangement (Bottom View)

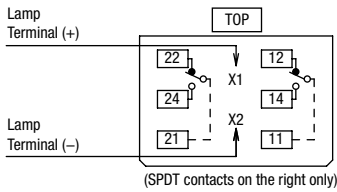

Panel Cut-out for Positioning (LB1L/LB2L/LB3L/LB4L)

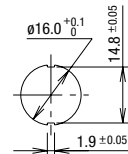

Mounting Hole Layout (LB1L/LB2L/LB3L/LB4L)

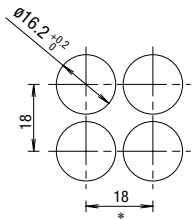







\*: 24 mm for rectangular units.  
 Note: When using rubber boot or terminal cover, see dimensions on B-127 and B-128.

- For details on pc board and circuit design, see B-121.
- For details on single board mounting, see B-122.

## Pilot Lights

Package Quantity:1

## Solder/Tab Terminal

Part No. / Shape	LB ① P - ② T ③ ④ *						
							
	Round		Square		Rectangular	Rectangular with 3-sided Barrier	Dome
② Lens Shape	③ LED Operating Voltage		Part No.	* Illumination Color Code			
Flush	24V AC/DC		LB①P-1T04*	Specify the color code in place of * in the Part No. A: amber G: green PW: pure white R: red S: blue Y: yellow			
Dome	24V AC/DC		LB1P-2T04*				

- Pilot lights contain an LED unit. For maintenance LED units see **B-130**.
- Legends and symbols can be engraved on a marking plate or film to be inserted under the lens by users for labelling purposes. See **B-133** for details.
- PC board terminals available. To specify, see Part Number Development below.
- 5V DC and 12V AC/DC LED operating voltages also available. To specify, see Part Number Development below.

## Part Number Development

## LB ① P - ② T ③ ④ \*

## ① Shape

Code	Shape
1	Round
2	Square
3	Rectangular
4	Rectangular with 3-sided Barrier

## ② Lens Shape

Code	Lens Shape
1	Flush
2	Dome

## ③ LED Operating Voltage

Code	Rated Operating Voltage
1	5V DC
3	12V AC/DC
4	24V AC/DC

- Round only for dome.

## ④ Others

Code	Specification	Part No. Example
Blank	Solder/Tab Terminal	—
V	PC Board Terminal	LB1P-1T04V*

- Specify the color code in place of \* in the table above

LB

A6

APEM

Switches & Pilot Lights

Control Boxes

Emergency Stop Switches

Enabling Switches

Safety Products

Explosion Proof

Terminal Blocks

Relays & Sockets

Circuit Protectors

Power Supplies

LED Illumination

Controllers

Operator Interfaces

Sensors

AUTO-ID

Flush Silhouette

ø16

ø22

ø30

Miniature

Pilot Lights

LB

A6

Dimensions

All dimensions in mm.

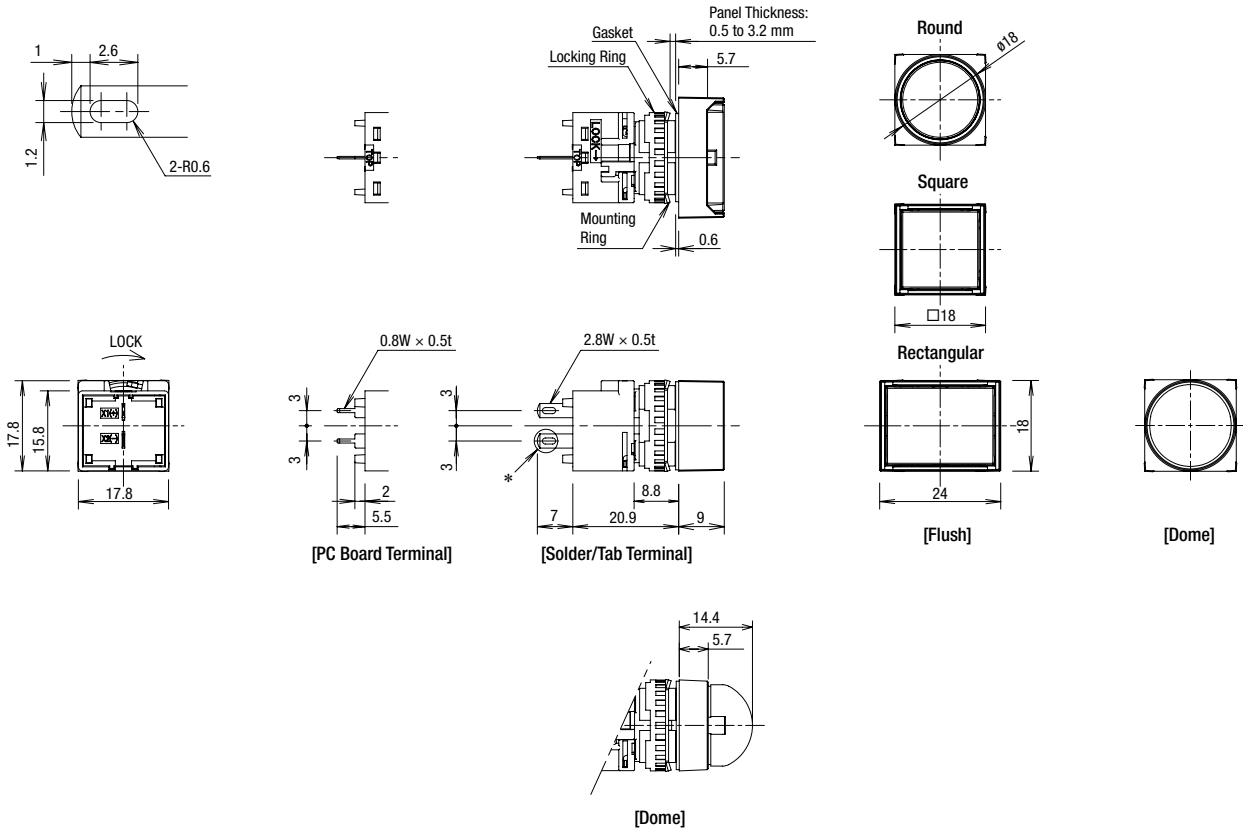

Terminal Arrangement (Bottom View)

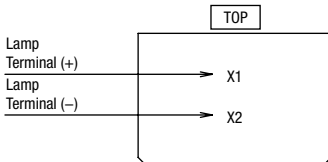

Panel Cut-out for Positioning (LB1P/LB2P/LB3P/LB4P)

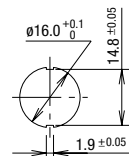

Mounting Hole Layout

(LB1P/LB2P/LB3P/LB4P)

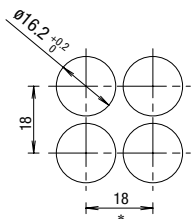

\*: 24 mm for rectangular units.

Note: When using rubber boot or terminal cover, see dimensions on B-127 and B-128.

- For details on pc board and circuit design, see B-121.
- For details on single board mounting, see B-122.

## Pushbuttons

Solder/Tab Terminal

Package Quantity:1

Button Style	② Operation	③ Contact	Part No.		* Illumination Color Code
			Gold Contact	Silver Contact	
Button	Momentary	SPDT	LB⓪B-M1T1*	LB⓪B-M1T5*	B: black G: green R: red S: blue W: white Y: yellow
		DPDT	LB⓪B-M1T2*	LB⓪B-M1T6*	
		3PDT	LB⓪B-M1T3*	LB⓪B-M1T7*	
	Maintained	SPDT	LB⓪B-A1T1*	LB⓪B-A1T5*	
		DPDT	LB⓪B-A1T2*	LB⓪B-A1T6*	
		3PDT	LB⓪B-A1T3*	LB⓪B-A1T7*	
Lens	Momentary	SPDT	LB⓪B-M1T1L*	LB⓪B-M1T5L*	A: amber G: green R: red S: blue W: white Y: yellow
		DPDT	LB⓪B-M1T2L*	LB⓪B-M1T6L*	
		3PDT	LB⓪B-M1T3L*	LB⓪B-M1T7L*	
	Maintained	SPDT	LB⓪B-A1T1L*	LB⓪B-A1T5L*	
		DPDT	LB⓪B-A1T2L*	LB⓪B-A1T6L*	
		3PDT	LB⓪B-A1T3L*	LB⓪B-A1T7L*	

- Lens can be used with legend markings. Engraving can be done on a marking plate which is placed in the lens, or a clear film can be printed and placed in the lens. See **B-133** for details on the marking plate and film.
- Black is available for lens. Black lens consists of a transparent lens and a black marking plate. To specify, see Part Number Development below.
- PC board terminals available for gold contacts. To specify, see Part Number Development below.

## Part Number Development

LB⓪B-②1T③④\*

## ① Shape

Code	Shape
1	Round
2	Square
3	Rectangular
4	Rectangular with 3-sided Barrier

## ② Operation

Code	Operation
A	Maintained
M	Momentary

## ③ Contacts

Code	Contact
1	Gold/SPDT
2	Gold/DPDT
3	Gold/3PDT
5	Silver/SPDT
6	Silver/DPDT
7	Silver/3PDT

## ④ Others

Code	Specification	Part No. Example
Blank	Solder/Tab Terminal	—
B	Black Translucent Lens (Lens Only)	LB1B-M1T1LB
V	PC Board Terminal (Gold Contact Only)	LB1B-M1T1V*

Dimensions

All dimensions in mm.

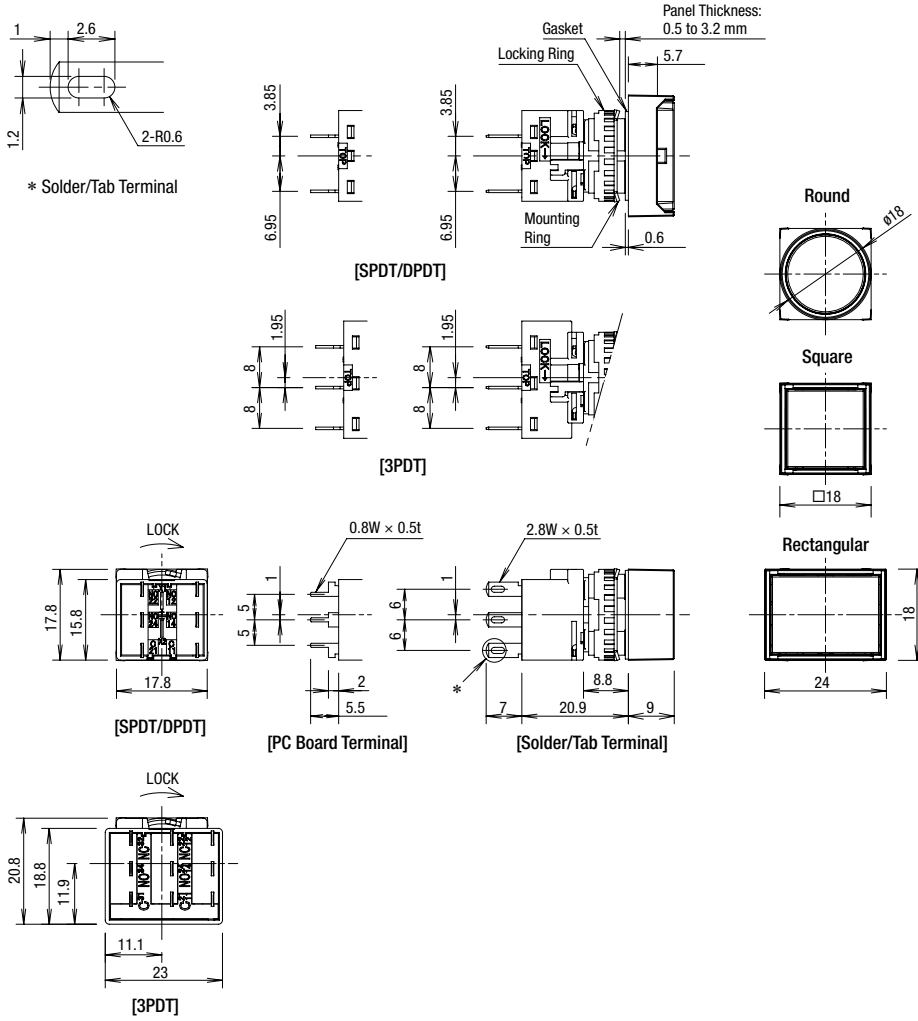

Terminal Arrangement (Bottom View)

SPDT/DPDT Contacts

3PDT Contacts

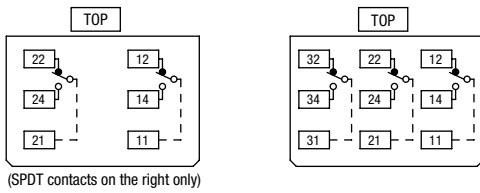

Mounting Hole Layout

(LB1B/LB2B/LB3B/LB4B)

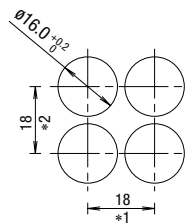

Panel Cut-out for Positioning

(LB1B/LB2B/LB3B/LB4B)

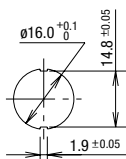

\*1: 24 mm for rectangular units, 23.2 mm for 3PDT

\*2: 21 mm for 3PDT

Note: When using rubber boot or terminal cover, see dimensions on **B-127** and **B-128**.

- For details on pc board and circuit design, see **B-121**.
- For details on single board mounting, see **B-122**.

APEM

Switches & Pilot Lights

Control Boxes

Emergency Stop Switches

Enabling Switches

Safety Products

Explosion Proof

Terminal Blocks

Relays & Sockets

Circuit Protectors

Power Supplies

LED Illumination

Controllers

Operator Interfaces

Sensors

AUTO-ID

Flush Silhouette

ø16

ø22

ø30

Miniature

Pilot Lights

LB

A6













## Selector Switches

Solder/Tab Terminal

Package Quantity:1

Part No. / Shape	LB ① S - ② ③ T ④ ⑤					
	Knob Operator			Lever Operator		
						
	Round	Square	Rectangular	Round	Square	Rectangular
② Operator Position		③ Contact		Part No.		
				Gold Contact	Silver Contact	
90° 2-position	Maintained 		SPDT	LB ① S-2T1	LB ① S-2T5	
			DPDT	LB ① S-2T2	LB ① S-2T6	
			3PDT	LB ① S-2T3	LB ① S-2T7	
45° 3-position	Maintained 		DPDT	LB ① S-3T2	LB ① S-3T6	
			3PDT	LB ① S-3T3	LB ① S-3T7	
	Spring return two-way 		DPDT	LB ① S-33T2	LB ① S-33T6	
			3PDT	LB ① S-33T3	LB ① S-33T7	

- Lever operators also available. To specify, see Part Number Development below.
- PC board terminals available for gold contacts. To specify, see Part Number Development below.
- 2-position spring return from right, 3-position spring return from right, 3-position spring return from left also available. To specify, see Part Number Development below.
- For contact operation, see **B-119**.

## Part Number Development



## LB ① S - ② ③ T ④ ⑤

## ① Shape





Code	Shape
1	Round
2	Square
3	Rectangular

## ② Operator Position

## 2-position

Operator Position	
2 Maintained 	21 Spring return from right 

## 3-position

Operator Position			
3 Maintained 	31 Spring return from right 	32 Spring return from left 	33 Spring return two-way 

## ③ Operator

Code	Operator Shape
Blank	Knob
L	Lever

## ④ Contacts

Code	Contact
1	Gold/SPDT (90° 2-position only)
2	Gold/DPDT
3	Gold/3PDT
5	Silver/SPDT (90° 2-position only)
6	Silver/DPDT
7	Silver/3PDT

## ⑤ Others

Code	Specification	Part No. Example
Blank	Solder/Tab Terminal	—
V	PC Board Terminal (Gold Contact Only)	LB1S-2T1V

Dimensions

All dimensions in mm.

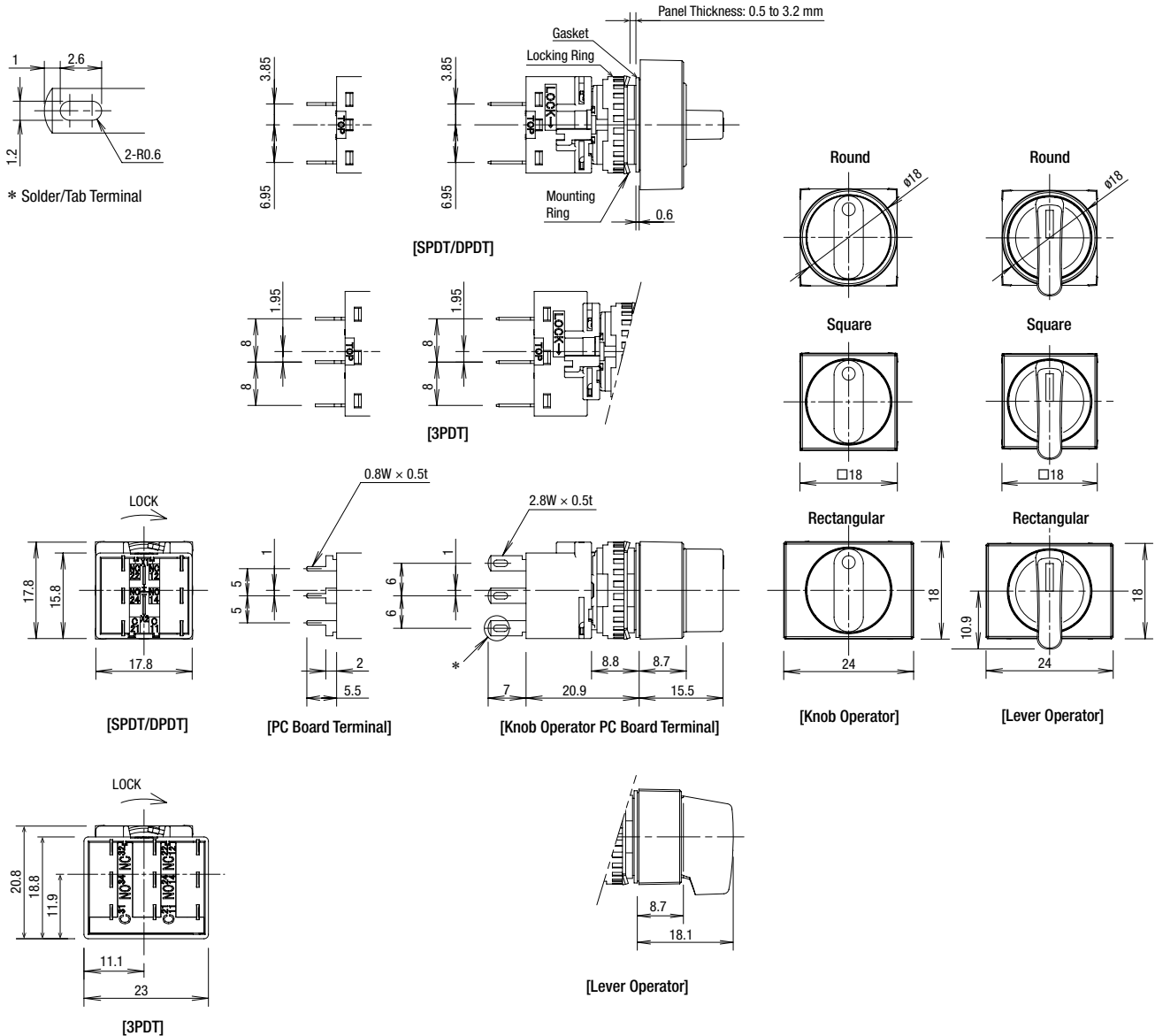

Terminal Arrangement (Bottom View)

SPDT/DPDT Contacts

3PDT Contacts

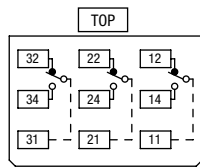
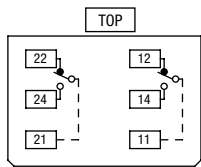

(SPDT contacts on the right only)

Mounting Hole Layout

(LB1S/LB2S/LB3S)

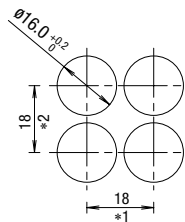

Panel Cut-out for Positioning

(LB1S/LB2S/LB3S)

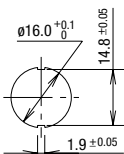

\*1: 24 mm for rectangular units, 23.2 mm for 3PDT

\*2: 21 mm for 3PDT

Note: When using terminal cover, see dimensions on B-128.

- For details on pc board and circuit design, see B-121.
- For details on single board mounting, see B-122.

APEM

Switches & Pilot Lights

Control Boxes

Emergency Stop Switches

Enabling Switches

Safety Products

Explosion Proof

Terminal Blocks

Relays & Sockets

Circuit Protectors

Power Supplies

LED Illumination

Controllers

Operator Interfaces

Sensors

AUTO-ID

Flush Silhouette

ø16

ø22

ø30

Miniature

Pilot Lights



LB

A6

## Illuminated Selector Switches

Solder/Tab Terminal

Package Quantity:1

Part No. / Shape	LB ① F - ② T ③ ④ ⑤ *					
	② Operator Position	③ Contact	④ LED Operating Voltage	Part No.		* Illumination Color Code
				Gold Contact	Silver Contact	
90° 2-position	Maintained 	SPDT	24V AC/DC	LB ① F-2T14*	LB ① F-2T54*	Specify the color code in place of * in the Part No. G: green R: red PW: pure white
		DPDT	24V AC/DC	LB ① F-2T24*	LB ① F-2T64*	
45° 3-position	Maintained 	DPDT	24V AC/DC	LB ① F-3T24*	LB ① F-3T64*	

- Illuminated selector switches contain an LED unit. For maintenance LED units see **B-130**.
- PC board terminals available for gold contacts. To specify, see Part Number Development below.
- 5V DC and 12V AC/DC LED operating voltages also available. To specify, see Part Number Development below.
- For contact operation, see **B-119**.

## Part Number Development



LB ① F - ② T ③ ④ ⑤ \*

## ① Shape

Code	Shape
1	Round
2	Square
3	Rectangular

## ② Operator Position

2-position 3-position

Operator Position	
2 Maintained 	3 Maintained 

## ③ Contacts

Code	Contact
1	Gold/SPDT (90° 2-position only)
2	Gold/DPDT
5	Silver/SPDT (90° 2-position only)
6	Silver/DPDT

## ④ LED Operating Voltage

Code	Rated Operating Voltage
1	5V DC
3	12V AC/DC
4	24V AC/DC

## ⑤ Others

Code	Specification	Part No. Example
Blank	Solder/Tab Terminal	—
V	PC Board Terminal (Gold Contact Only)	LB1F-2T14V*

- Specify a color code in place of \* in the Part No.

- APEM
- Switches & Pilot Lights
- Control Boxes
- Emergency Stop Switches
- Enabling Switches
- Safety Products
- Explosion Proof
- Terminal Blocks
- Relays & Sockets
- Circuit Protectors
- Power Supplies
- LED Illumination
- Controllers
- Operator Interfaces
- Sensors
- AUTO-ID

- Flush Silhouette
- ø16
- ø22
- ø30
- Miniature
- Pilot Lights

- LB
- A6

Dimensions

All dimensions in mm.

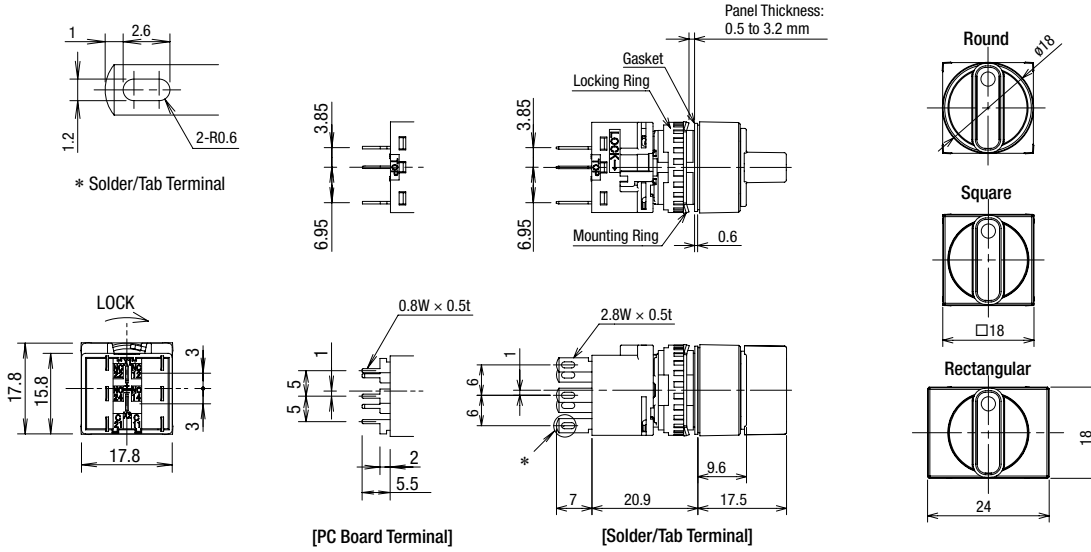

Terminal Arrangement (Bottom View)

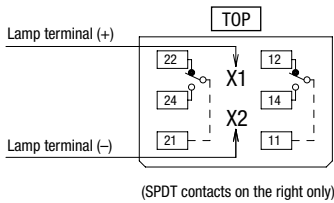

Panel Cut-out for Positioning

Round (LB1F/LB2F/LB3F)

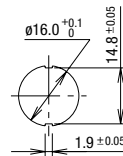

Mounting Hole Layout

Round (LB1F/LB2F/LB3F)

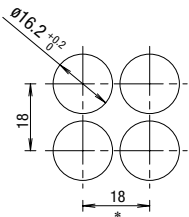

\*: 24 mm for rectangular units.

Note: When using terminal cover, see dimensions on B-128

- For details on pc board and circuit design, see B-121.
- For details on single board mounting, see B-122.



Download catalogs and CAD from <http://eu.idec.com/downloads>

## Key Selector Switches

Package Quantity:1

## Solder/Tab Terminal

Part No. / Shape	LB ① K - ② ③ T ④ ⑤ - ⑥					
	② Operator Position	⑤ Key Removable Position	④ Contact	Part No.		
				Gold Contact	Silver Contact	
90° 2-position	Maintained	A: Key removable in all positions		SPDT	LB⓪K-2ST1A	LB⓪K-2ST5A
				DPDT	LB⓪K-2ST2A	LB⓪K-2ST6A
				3PDT	LB⓪K-2ST3A	LB⓪K-2ST7A
45° 3-position	Maintained	A: Key removable in all positions		DPDT	LB⓪K-3ST2A	LB⓪K-3ST6A
				3PDT	LB⓪K-3ST3A	LB⓪K-3ST7A



Round



Square



Rectangular

- For operator position, see Part Number Development below.
- For key removable position, see Part Number Development below. The key cannot be removed at the return position.
- Two keys are supplied.
- Besides the standard key (key number 0H), six other keys are available.
- Disc tumbler keys also available. Only the standard key is available. To specify, see Part Number Development below.
- PC board terminals available for gold contacts. To specify, see Part Number Development below.
- For contact operation, see B-119.

## Part Number Development

LB ① K - ② ③ T ④ ⑤ - ⑥

## ① Shape

Code	Shape
1	Round
2	Square
3	Rectangular

## ② Operator Position

Code	Operator Position
2	90° 2-position maintained
21	90° 2-position spring return from right
3	45° 3-position maintained
31	45° 3-position spring return from right
32	45° 3-position spring return from left
33	45°-3-position spring return two-way

## ③ Key Style

Code	Key Style
S	Wave key
Blank	Disc tumbler key

## ④ Contacts

Code	Contact
1	Gold/SPDT (90° 2-position only)
2	Gold/DPDT
3	Gold/3PDT
5	Silver/SPDT (90° 2-position only)
6	Silver/DPDT
7	Silver/3PDT

## ⑤ Key Removal Position

## 2-position

Key Removable Position			Spring return from right
A: Key removable in all positions	B: Key removable at left	C: Key removable at right	

## 3-position

Key Removable Position			
A: Key removable in all positions	B: Key removable at left / center	C: Key removable at center / right	D: Key removable at center
E: Key removable at right / left	G: Key removable at left	H: Key removable at right	

For key selectors with the following operations, the key cannot be removed at the return position.

## 3-position

Spring return from right	Spring return from left	Spring return two-way

- Key is removable at L, C, R. Key is retained at L, C, and R.

## ⑥ Key Number

Code	Key Number
Blank	Standard key (0H)
1H to 2H	Reversible key
3H to 6H	Non-reversible key

- Wave key only.

## Others

Code	Specification	Part No. Example
Blank	Solder/Tab Terminal	—
V	PC Board Terminal (Gold Contact Only)	LB1K-2ST1VA

APEM

Switches & Pilot Lights

Control Boxes

Emergency Stop Switches

Enabling Switches

Safety Products

Explosion Proof

Terminal Blocks

Relays & Sockets

Circuit Protectors

Power Supplies

LED Illumination

Controllers

Operator Interfaces

Sensors

AUTO-ID

Flush Silhouette

ø16

ø22

ø30

Miniature

Pilot Lights

LB

A6

Dimensions

All dimensions in mm.

Key Selector Switches with Wave Key

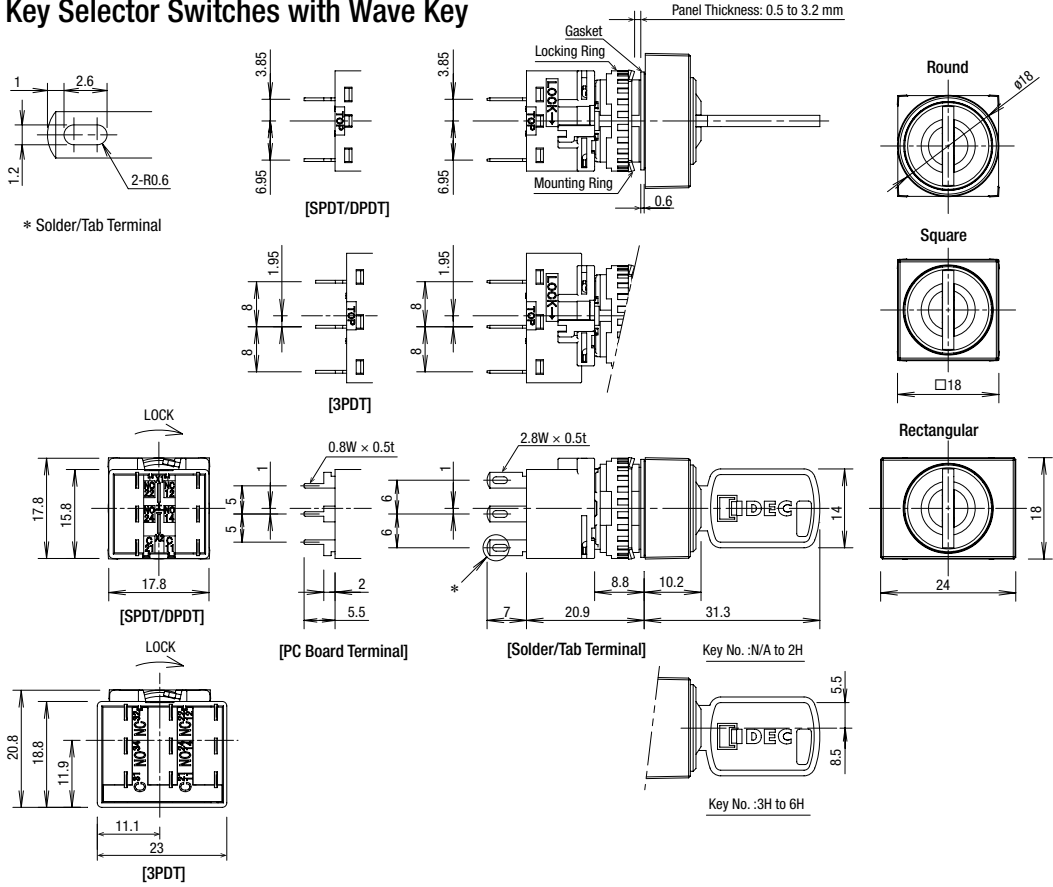

Key Selector Switches with Disc Tumbler Key

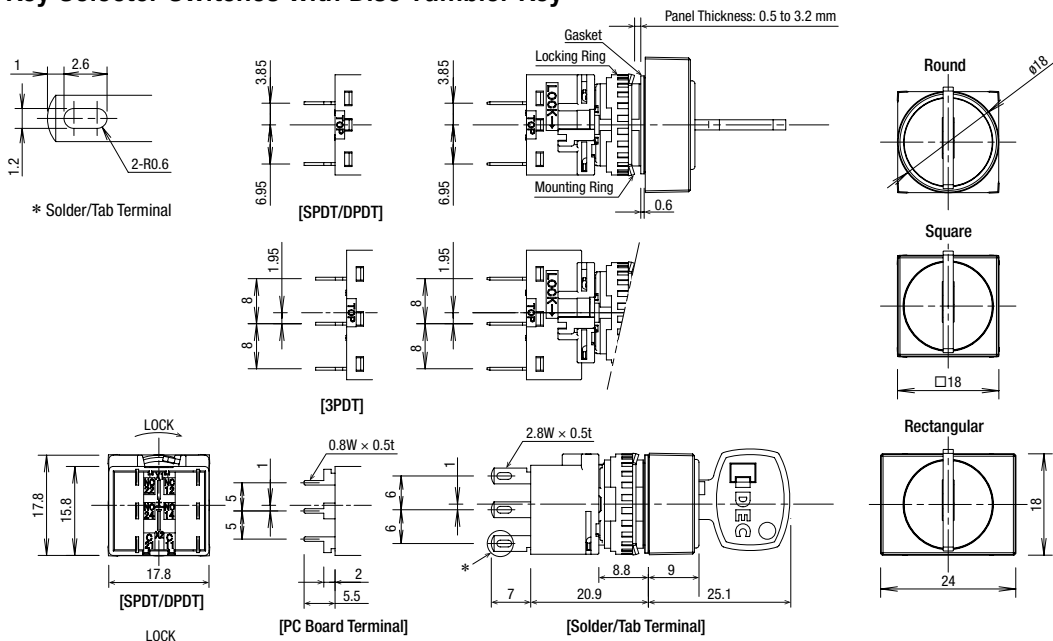

Terminal Arrangement (Bottom View)

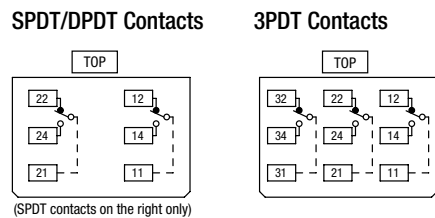

- For details on mounting hole layout, see B-110.
- For details on pc board and circuit design, see B-121.
- For details on single board mounting, see B-122.

**Lever Switches**

Package Quantity:1

**Solder/Tab Terminal**

Part No. / Shape	Operator Position	Contact	Part No.		
			Gold Contact	Silver Contact	
2-position	Maintained	 U D	SPDT	LB1T-2T1	LB1T-2T5
			DPDT	LB1T-2T2	LB1T-2T6
			3PDT	LB1T-2T3	LB1T-2T7
3-position	Maintained	 U C D	DPDT	LB1T-3T2	LB1T-3T6
			3PDT	LB1T-3T3	LB1T-3T7
	Spring return from top/bottom	 U C D	DPDT	LB1T-33T2	LB1T-33T6
			3PDT	LB1T-33T3	LB1T-33T7

- PC board terminals available for gold contacts. Add "V" to the Part No. Example: LB1T-2T1V
- For contact operation, see **B-119**.

**Dimensions**

All dimensions in mm.

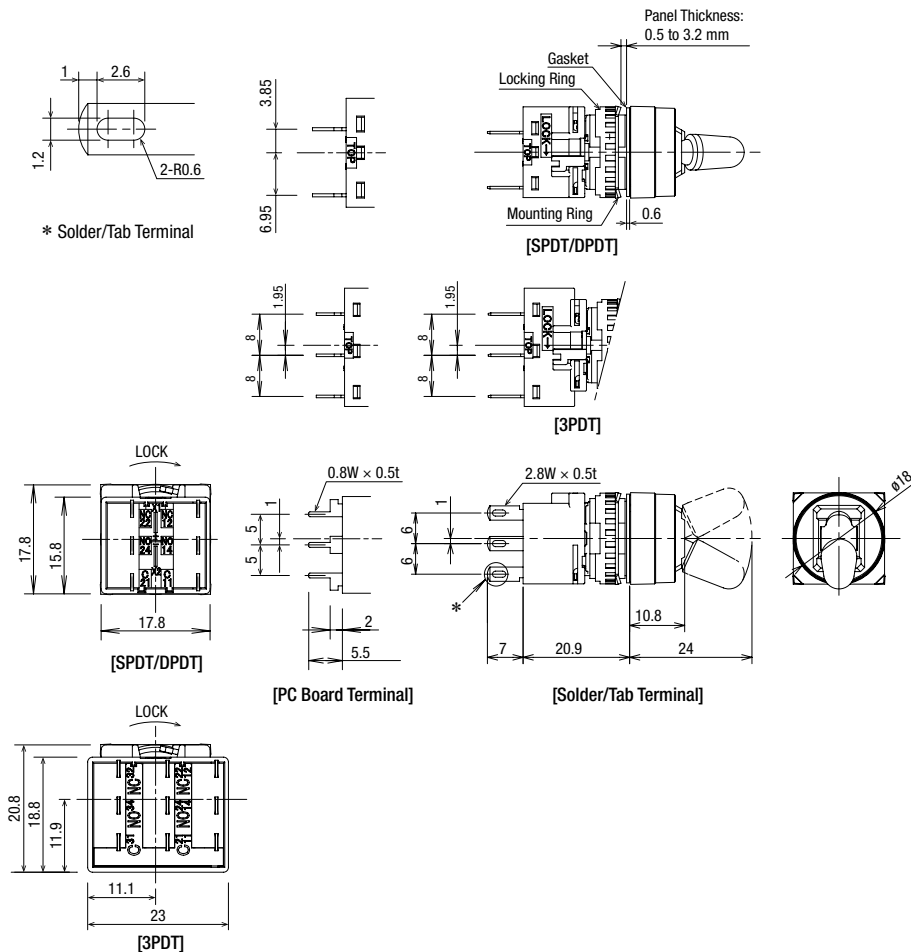

**Terminal Arrangement (Bottom View)**

**SPDT/DPDT Contacts**

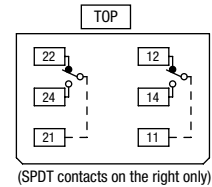

**3PDT Contacts**

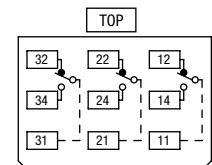

- For details on mounting hole layout, see **B-110**.
- For details on pc board and circuit design, see **B-121**.
- For details on single board mounting, see **B-122**.

Buzzers

Specifications

Rated Insulation Voltage	30V
Rated Operating Voltage	12, 24V DC
Operating Voltage Range	12V DC±10%, 24V DC±10%
Current Draw	26mA
Inrush Current	80mA maximum
Sound Pressure (at 0.1m)	Steady sound: 80 dB minimum (at the rated voltage)
Sound Frequency	2.3±0.3kHz
Response Speed	50 ms maximum
Operating Temperature	-25 to +60°C (no freezing)
Storage Temperature	-30 to +80°C(no freezing)
Operating Humidity	45 to 85% (no condensation)
Insulation Resistance	100 MΩ minimum (500V DC megger)

Dielectric Strength	Between live and dead parts: 1,000V AC, 1 minute
Vibration Resistance	Operating extremes/Damage limits: 5 to 55 Hz, amplitude 0.5 mm
Shock Resistance	Operating extremes: 100m/s <sup>2</sup> Damage limits: 1,000m/s <sup>2</sup>
Life	1,000 hours minimum (beep sound)
Degree of Protection	LB3Z-1T0*: IP54 (IEC60529) LB3Z-104K: IP40 (IEC60529)
Terminal Style	LB3Z-1T0*: Solder/tab terminal #110 PC board terminal LB3Z-104K: Solder terminal
Weight (approx.)	11g (LB3Z-1T0*), 8g (LB3Z-104K)

• For applicable standards and UL, CSA ratings, see **B-089**.

Name and Shape	Operating Voltage	Terminal Style	Part No.	
			IP54	IP40
 IP54      IP40	24V DC	Solder/tab terminal	<b>LB3Z-1T04</b>	—
		PC board terminal	<b>LB3Z-1T04V</b>	—
		Solder terminal	—	<b>LB3Z-104K</b>

• 12V DC operating voltages also available. Specify “-1T04” in place of “-1T03” in the Part No.  
Example: **LB3Z-1T03**

Dimensions

IP54

Terminal Arrangement (Bottom View)

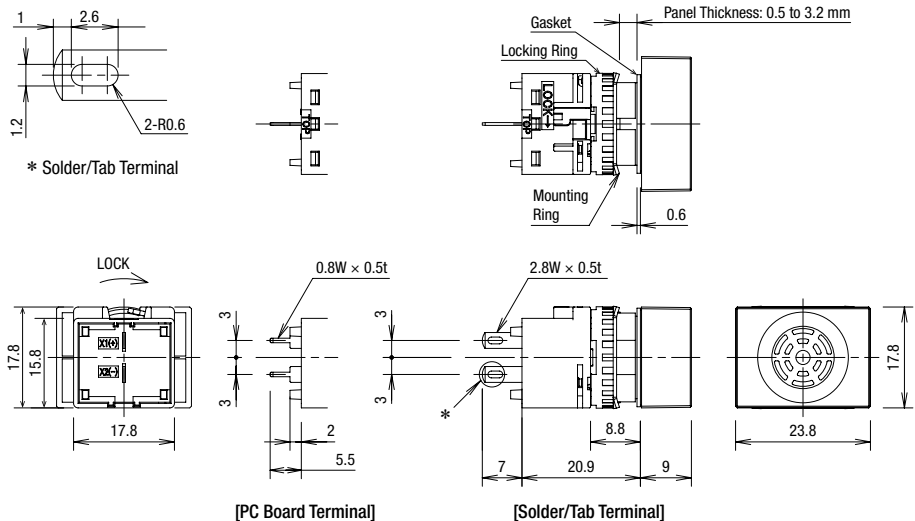
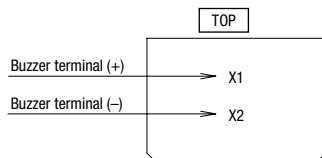

IP40

Terminal Arrangement (Bottom View)

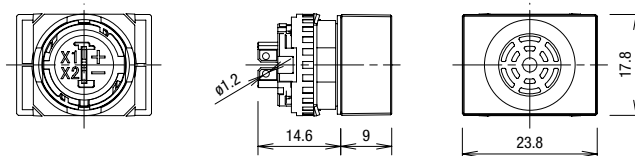
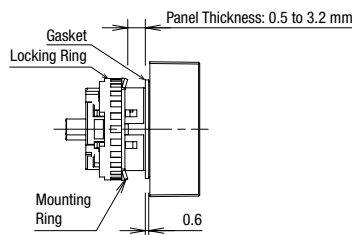
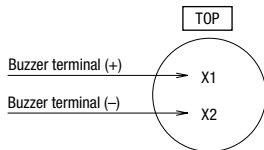

- For details on mounting hole layout, see **B-110**.
- For details on pc board and circuit design, see **B-121**.
- For details on single board mounting, see **B-122**.

All dimensions in mm.



Contact Operation

Selector Switch / Illuminated Selector Switch / Key Selector Switch

Operator Position & Contact Operation (Top View)					
Position		Contact	↙ Left	↑ Center	↘ Right
90° 2-position	<p>Maintained                      Spring return from right</p>	SPDT		/	
		DPDT		/	
		3PDT		/	
45° 3-position	<p>Maintained      Spring return from right      Spring return from left      Spring return two-way</p>	DPDT			
		3PDT			

Lever Switch

Lever Position & Contact Operation (Top View)					
Position		Contact	Down	Center	Up
90° 2-position	<p>Maintained</p>	SPDT		/	
		DPDT		/	
		3PDT		/	
45° 3-position	<p>Maintained                      Spring return two-way</p>	DPDT			
		3PDT			

- APEM
- Switches & Pilot Lights
- Control Boxes
- Emergency Stop Switches
- Enabling Switches
- Safety Products
- Explosion Proof
- Terminal Blocks
- Relays & Sockets
- Circuit Protectors
- Power Supplies
- LED Illumination
- Controllers
- Operator Interfaces
- Sensors
- AUTO-ID

- Flush Silhouette
- ø16
- ø22
- ø30
- Miniature
- Pilot Lights

- CW
- LBW-F
- LB
- LBW
- UP
- Flush Bezel

## Mounting Hole Layout / PC Board Drilling Layout

### LB Series Flush Bezel

#### Round (LB6/LB6M)

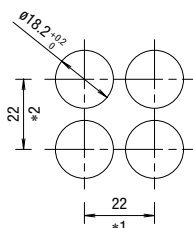

\*1: 23.2 mm for 3PDT contacts  
\*2: 45 mm for switches with guard

#### Square (LB7/LB7M)

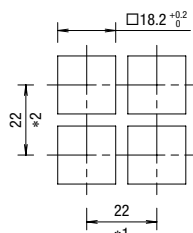

Note: When using the LB series with a rubber boot or terminal cover, make sure to note the dimensions on **B-128**.

#### Rectangular (LB8/LB8M)

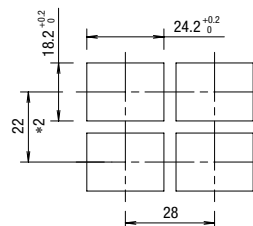

### LBW Series Flush Bezel

#### Round (LBW6/LB6M/LBW6G)

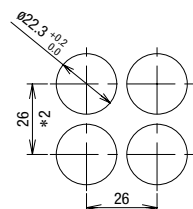

\* 53 mm for switches with guard

#### Square (LBW7/LBW7M/LBW7G)

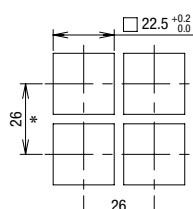

\* 53 mm for switches with guard

### LB Series Standard Bezel

#### (LB1/LB2/LB3)

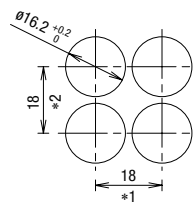

\*1: 24 mm for rectangular type  
23.2 mm for 3PDT contacts  
\*2: 21 mm for 3PDT contacts

### Panel Cut-out for Positioning

#### LB Series Flush Bezel Round (LB6/LB6M)

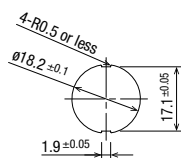

#### LBW Series Flush Bezel Round (LBW6/LBW6M/LBW6G)

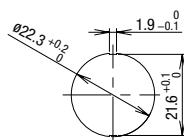

#### LB Series Standard Bezel Round (LB1/LB2/LB3)

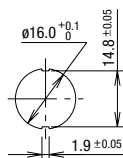

## Approval Ratings and CCC Approval File No.

### UL

#### Gold Contact

Rated Operating Voltage	30V DC	125V AC
Rated Operating Current	0.1A	0.1A

#### Silver Contact

Rated Operating Voltage		30V	125V	250V	
Rated Operating Current	AC	Res.	—	3.5 A	
		Ind.	—	2A	
	DC	Res.	2, 3, 5A	0.4A	—
		Ind.	1A	0.2A	—

### CSA

#### Gold Contact

Rated Operating Voltage	30V DC	125V DC
Rated Operating Current	0.1A	0.1A

#### Silver Contact

Rated Operating Voltage		30V	125V	250V	
Rated Operating Current	AC	Res.	—	3A	
		Ind.	—	2A	
	DC	Res.	2, 5A	0.4A	—
		Ind.	1A	0.2A	—

### TÜV

#### Gold Contact

Rated Operating Voltage	30V DC	125V AC
Rated Operating Current	0.1A (DC-12)	0.1A (AC-12)

#### Silver Contact

Rated Operating Voltage		30V	125V	250V
Rated Operating Current	AC-12	—	3A	2, 5A
	DC-12	2, 5A	0.4A	—

### CCC

#### Gold Contact

Rated Operating Voltage	30V DC	125V AC
Rated Operating Current	0.1A (DC-12)	0.1A (AC-12)

#### Silver Contact

Rated Operating Voltage		30V	250V
Rated Operating Current	AC-12	—	2, 5A
	DC-12	2, 5A	—



Download catalogs and CAD from <http://eu.idec.com/downloads>

## Notes for Designing PC Board and Circuit

All dimensions in mm.

- Use 1.6-mm-thick glass epoxy PC board with drilled holes.
- Design a circuit so that the LB/LBW series can operate within the rated voltage and current range. Make sure that inrush current and voltage do not exceed the rating.
- Minimum applicable load is 5V AC/DC, 1 mA on gold contacts. Applicable range is subject to the operating condition and load.
- Since the \*2.8-mm-wide terminal touches the PC board as shown on the right, short circuit may occur with pattern lines. Design a circuit that prevents short circuits.

## SPDT/DPDT Contacts

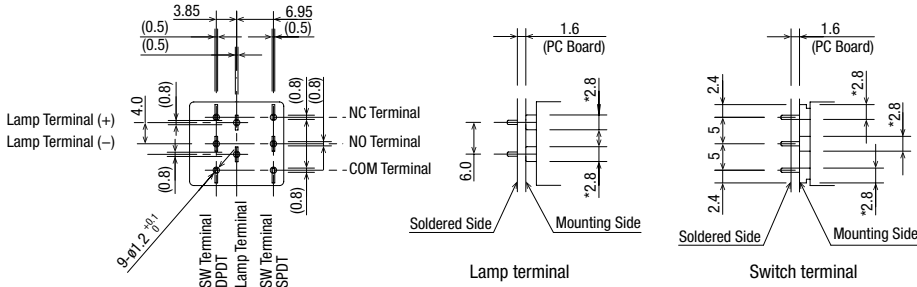

## 3PDT Contacts

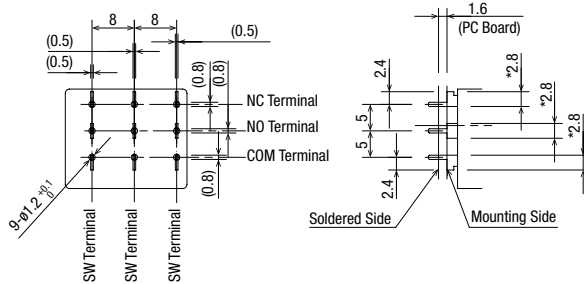

## PC Board Drilling Layout (Bottom View)

## SPDT/DPDT Contacts

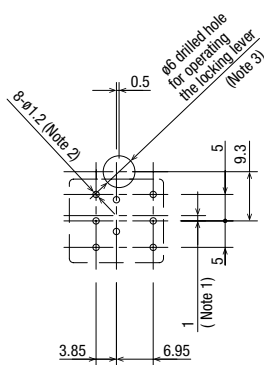

## 3PDT Contacts

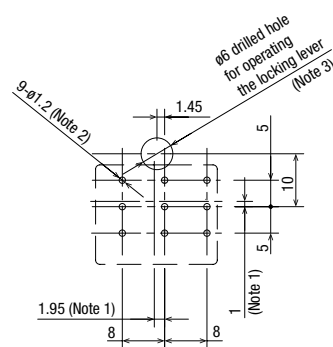

Note 1: When designing, note the alignment of center lines of the contact blocks and center lines of the operators.

Note 2: The diameter of the terminal hole is  $\phi 1.2$ .

Note 3: Hole diameter may vary to meet installation requirements. Determine the location and the size of the hole so that the locking lever can be operated.

APEM
Switches & Pilot Lights
Control Boxes
Emergency Stop Switches
Enabling Switches
Safety Products
Explosion Proof
Terminal Blocks
Relays & Sockets
Circuit Protectors
Power Supplies
LED Illumination
Controllers
Operator Interfaces
Sensors
AUTO-ID

Flush Silhouette
ø16
ø22
ø30
Miniature
Pilot Lights

CW
LW-F
LB
LBW
UP
Flush Bezel

## Single Board Mounting

IDEC's LB/LBW Series is available for single board mounting.

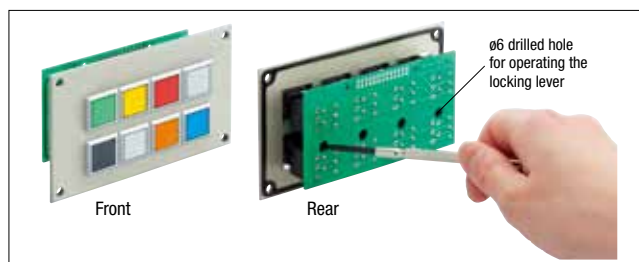

### Installing and Removing Contact Blocks

Turn the locking lever to install and remove contact blocks on the PC using a screwdriver from a hole in the PC board. See "Notes for Designing PC Board and Circuit" on **B-121**. Determine the location of the switches so that the locking lever can be operated. See "Removing and Installing the Contact Block" on **B-131**.

### Mounting Holes and Assembly Procedure

Drill mounting holes in the panel as shown below. When the units are mounted collectively, provide adequate clearance.

#### Panel Cut-out for Positioning

##### Standard Bezel (LB1/LB2/LB3/LB4)

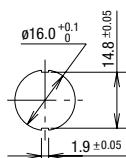

##### LB Series Flush Bezel (LB6/LB6M/LB6G)

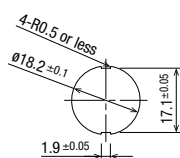

##### LBW Series Flush Bezel (LBW6/LBW6M/LBW6G)

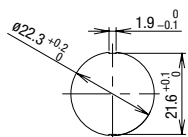

### Mounting Hole Layout

#### Standard Bezel (LB1/LB2/LB3/LB4)

##### SPDT/DPDT Contacts

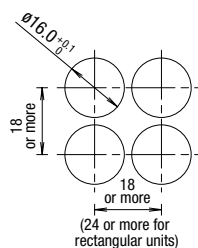

##### 3PDT Contacts

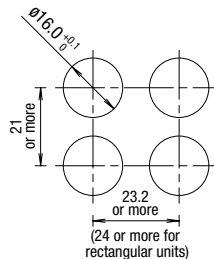

#### LB Series Flush Bezel

##### SPDT/DPDT Contacts

##### LB6/LB6M/LB6G

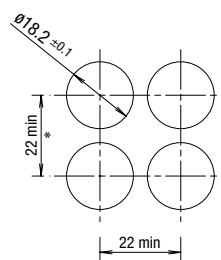

##### 3PDT Contacts

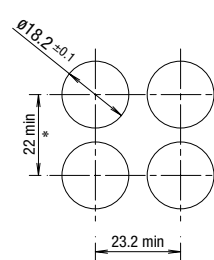

##### LB7/LB7M/LB7G

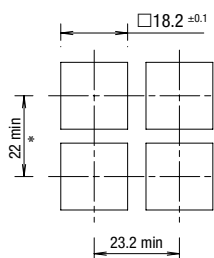
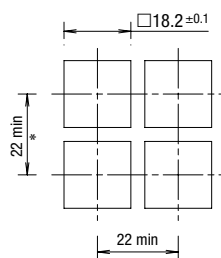

##### LB8/LB8M/LB8G

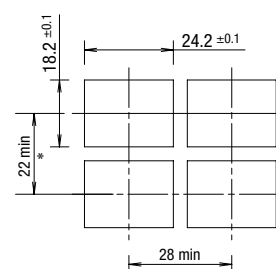
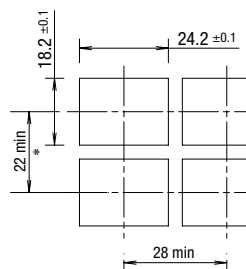

\* 45 mm minimum for switches with guard

#### LBW Series Flush Bezel

##### LBW6/LBW6M/LBW6G

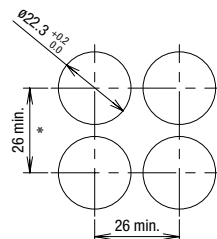

#### LBW Series Flush Bezel

##### LBW7/LBW7M/LBW7G

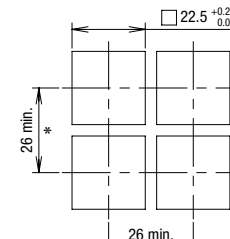

\* 53 mm minimum for switches with guard

### Assembly Procedure

1. Install the operator to the panel.
2. Mount the contact block to the operator from the rear.
3. Turn the locking lever to lock the contact block.
4. Insert the PC board to terminals and solder.

- Note 1: Make sure that each terminal is inserted into the PC board correctly.
- Note 2: Do not apply tensile force to the connector cable for an extended period of time.
- Note 3: Do not expose the contact block to water.
- Note 4: Ensure to lock contact blocks when the contact blocks are installed on the operators.

• UP series can be installed on the same board. For details, see **B-123**.



Download catalogs and CAD from <http://eu.idec.com/downloads>

# UP Series Single Board Mount Pilot Lights

## Mounts on the same panel as LB/LBW series



- Three illumination colors: Green (G), red (R), and white (W)

## Specifications

Color Code	Red (R), White (W)	G (Green)
Rated Current (I)	7mA	2mA
Maximum Current (I <sub>a</sub> : 25°C)	Reverse Voltage (V <sub>R</sub> )	9V
	Operating Temperature (T <sub>opr</sub> )	-25 to +55°C (no freezing)
	Storage Temperature (T <sub>stg</sub> )	-30 to +80°C (no freezing)
Forward Voltage (V <sub>f</sub> )	Standard value: 2V (I <sub>f</sub> =7mA)	Standard value: 2.7V (I <sub>f</sub> =2 mA)
Dielectric Voltage	Between live and dead parts: 500V AC, 1 minute	
Weight (approx.)	4.3g (UP8-89V1), 5.1g (UP8-89V2)	

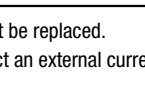

## UP Series

Mounting Hole Size	Shape	Degree of Protection (IEC 60529)	Mountable Unit	Part No.	Ordering No.	Illumination Color Code	Package Quantity
ø8 UP8  With standard bezel  With flush bezel	Shroud	IP40	Standard Bezel	UP8-89V1*	UP8-89V1*PN10	Specify the color code in place of * in the Part No. G: green R: red W: white	10
			Flush Bezel	UP8-89V2*	UP8-89V2*PN10		10
ø9 UP9P  	Shroud	IP65	Standard bezel Flush bezel	UP9P-99V1*	UP9P-99V1*PN10		10

- LED cannot be replaced.

Note: Connect an external current limiting resistor in series. Otherwise, the LED may be damaged.

## Dimensions

All dimensions in mm.

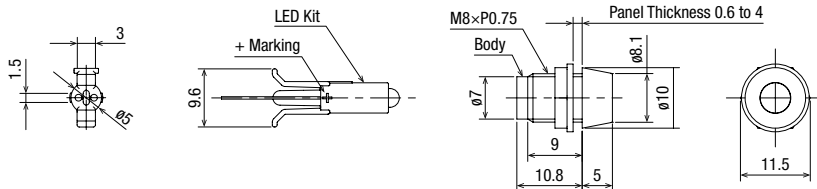

UP8-89V1

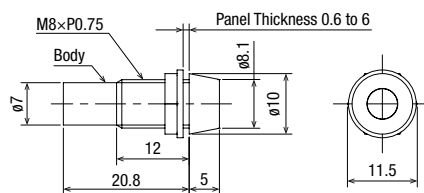

UP8-89V2

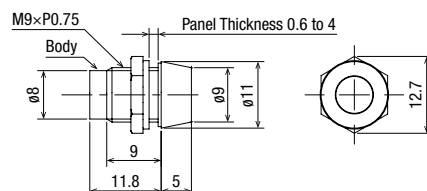

UP9P-99V1

## [Assembly Drawing]

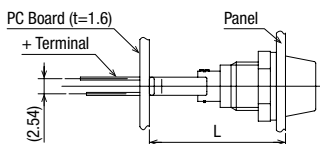

## Dimensions (L)

Standard Bezel	22.5mm
Flush Bezel	29.9mm

## PC Board Mounting Hole

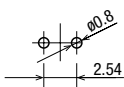

## Panel Cut-out

UP8

UP9P

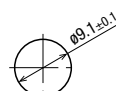
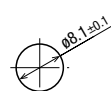

## Internal Circuit

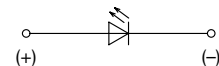

The longer pin is the positive terminal

**Safety Precautions**

- Turn off power to the unit before installation, removal, wiring, maintenance, and inspection. Failure to turn off may cause electrical shocks or fire hazard.
- For wiring, use wires of a proper size to meet the voltage and current requirements.
- Improper soldering or failure to tighten the terminal screw may cause overheating and fire.

**Single Board Mounting**

UP series miniature pilot light single board mounting types can be mounted with LB/ LBW series on the same panel.

Follow the instructions below on single board mounting.

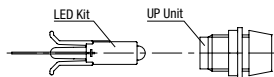

1. Mount the LED kit to the PC board.

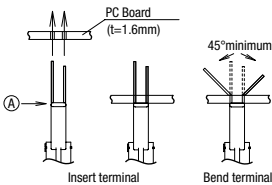

**Temporary mounting**

1. Note the polarity of the terminals and insert the terminals to the PC board.
2. Make sure that part A of the LED kit is pressed tightly to the PC board. Bend the terminals sideways as shown on the left.

2. Mount the operator and the UP series pilot lights on to the control panel.

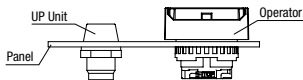

3. Mount the contact block to the operator of the miniature control unit and lock the unit by turning the locking lever.

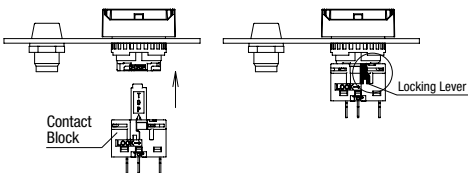

4. Install the PC board in 1. to the panel in 3.

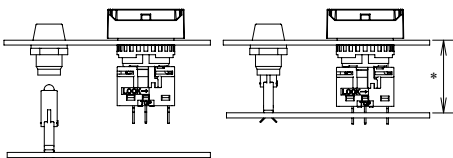

Note: Make sure that the LED kit is inserted into the UP series unit.

\* When mounting LB/LBW and UP series on a single board, make sure that the distance between the front of the panel and the mounting side of the PC board (gasket distortion is taken into consideration) is as shown in the table below.

Part No.	Mountable Unit	Distance (*)
UP8-89V1*	Standard bezel	22.5mm
UP8-89V2*	Flush bezel	29.9mm
UP9P-99V1*	Standard bezel	22.5mm
	Flush bezel	29.9mm

5. Solder the terminals.

Before soldering, make sure that each terminal of the contact block is securely inserted into the PC board holes.

**Instructions**

**Polarity**

Pay attention to the polarity of the power supply as UP series units do not contain a diode for protection against reverse polarity. The long terminal is positive and the short terminal is negative.

**Current Limiting Resistor**

When using a UP series unit without a built-in current limiting resistor, connect an external current limiting resistor. Calculate the resistance using the following formula.

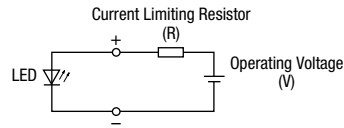

$$\text{Resistance } (\Omega) = \frac{\text{Operating Voltage (V)} - \text{Forward Voltage (Vf)}}{\text{Rated Current (I) *}}$$

- \* Rated Current (I) = R (red), W (white) : 0.007A  
G (green) : 0.002A
- Forward Voltage (Vf) = R (red), W (white) : 2V  
G (green) : 2.7V

Note: Use a resistor of higher resistance than the calculated value (Ω)

$$\text{Rated Wattage of Resistor (W)} = \text{Rated Current (I)} \times \text{Operating Voltage (V)} \times 2 \text{ to } 3 *$$

\* 2 to 3 is a safety factor

**<Current Limiting Resistor Reference Value>**

Operating Voltage / Color	Red (R), White (W)	Green (G)
5V DC	430Ω (1/4W)	1200Ω (1/4W)
6V DC	560Ω (1/4W)	1600Ω (1/4W)
12V DC	1500Ω (1/4W)	4700Ω (1/4W)
24V DC	3000Ω (1/2W)	11000Ω (1/4W)

**Countermeasures against Dim Lighting**

See B-136.

**Wiring**

Solder the terminal at 350°C within 3 seconds using a 60W soldering iron. SnAgCu type lead-free solder is recommended. When soldering, do not touch the pilot light housing with the terminal. Do not bend the terminal or apply excessive force to the terminal.

**Notes on Panel Mounting**

Tightening torque should not exceed 0.49 N·m. Do not use pliers. Do not tighten with excessive force, otherwise the locking ring will be damaged.

**PC Board and Circuit Design**



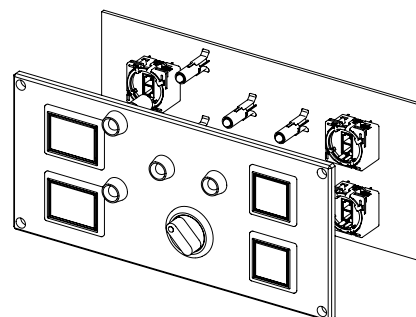





Use glass epoxy copper clad laminate, double-sided through-hole PC boards with a thickness of 1.6 mm.

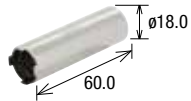

Example of single board mounting

## Accessories

Package Quantity:1

Shape	Specification	Part No.	Ordering No.	Package Quantity	Remarks		
Locking Ring Wrench 	Metal (Nickel-plated brass)	MT-001	MT-001	1	Used to tighten the locking ring when installing the units on to the panel.		
Lens Removal Tool 	Stainless Steel	MT-101	MT-101	1	Used to remove the lens or button. (for standard bezels)		
For Standard Bezels Switch Guard (spring return)	180° Spring return 	For round / square units (LB1/LB2)	Guard (Polyacetal)	AL-K6SP	AL-K6SP	1	Degree of protection: IP65 Used to protect pushbuttons and illuminated pushbuttons from inadvertent operation. See B-127 for dimensions. With the gasket mounted on the switch, attach the switch guard and mount on the panel.
		For rectangular units (LB3/LB4)	Base (Polyarylate)	AL-KH6SP	AL-KH6SP	1	
	180° Spring return for Single Board Mounting 	For rectangular units (LB3/LB4)	Guard (Polyacetal) Base (Polyarylate)	LA9Z-K3	LA9Z-K3	1	Degree of protection: IP65 With the gasket mounted on the switch, attach the switch guard and mount on the panel. See B-127 for dimensions.
	Remains 110°/180° open (Can be used for single board mounting) 	For round / square units (LB1/LB2)	Guard (Polyacetal) Base (Polyarylate)	LB9Z-K2	LB9Z-K2	1	Degree of protection: IP40 Used to protect pushbuttons and illuminated pushbuttons from inadvertent operation. See B-127 for dimensions. With the gasket mounted on the switch, attach the switch guard and mount on the panel. See B-136 for dimensions. When using for single board mounting, remove the rubber gasket from the switch.
		For rectangular units (LB3/LB4)		LB9Z-K3P	LB9Z-K3P	1	Degree of protection: IP65 With the gasket mounted on the switch, attach the switch guard and mount on the panel. See B-127 for dimensions.
	Rubber Boot 	1. For round units (LB1) 2. For square units (LB2) 3. For rectangular units (LB3/LB4)	Rubber (Transparent silicon rubber)	LB9Z-D1	LB9Z-D1	1	Degree of protection: IP65 See B-127 for dimensions. See B-135 for mounting.
			LB9Z-D2	LB9Z-D2	1		
			LB9Z-D3	LB9Z-D3	1		
Mounting Hole Plug 	Metal	[Plug] Metal (Zinc diecast) [Locking nut] Polyacetal [Gasket] Nitrile rubber	AL-BM6	AL-BM6	1	Degree of protection: IP65 Tightening torque: 0.1 to 0.29 N·m See B-127 for dimensions.	
Mounting Hole Plug 	Rubber	Nitrile rubber (black)	AL-B6	AL-B6PN05	5	Degree of protection: IP65 See B-127 for dimensions.	

APEM

Switches &amp; Pilot Lights

Control Boxes

Emergency Stop Switches

Enabling Switches

Safety Products

Explosion Proof

Terminal Blocks

Relays &amp; Sockets

Circuit Protectors

Power Supplies

LED Illumination

Controllers

Operator Interfaces

Sensors

AUTO-ID

Flush Silhouette

ø16

ø22

ø30

Miniature

Pilot Lights

CW

LW-F

LB







LBW

UP

Flush Bezel

## Accessories

Package Quantity:1

Shape		Specification	Part No.	Ordering No.	Package Quantity	Remarks	
For LB Series Flush Bezels	Rubber Boot	1. For round units (LB6/LB6M)	LB9Z-D6	LB9Z-D6	1	Degree of protection: IP65 See B-128 for dimensions. See B-135 for mounting.	
		2. For square units (LB7/LB7M)	LB9Z-D7	LB9Z-D7	1		
		3. For rectangular units (LB8/LB8M)	LB9Z-D8	LB9Z-D8	1		
	Mounting Hole Plug	1. For round units (LB6/LB6M)	[Plug] Polyamide (Black)	LB9Z-BS6*	LB9Z-BS6*	1	* Color code: blank (black), W (white) Degree of protection: IP65 Panel thickness: 0.5 to 3.2 mm See B-128 for dimensions.
			2. For square units (LB7/LB7M)	LB9Z-BS7*	LB9Z-BS7*	1	
			3. For rectangular units (LB8/LB8M)	[Mounting Plate] Stainless Steel	LB9Z-BS8*	LB9Z-BS8*	
For LBW Series Flush Bezels	Mounting Hole Plug	1. For round units (LBW6/LB6W6M)	[Plug] Polyamide (Black)	LBW9Z-BS6*	LBW9Z-BS6*	1	* Color code: blank (black), W (white) Degree of protection: IP65 Panel thickness: 0.5 to 3.2 mm See B-128 for dimensions.
			2. For rectangular units (LBW7/LB6W7M)	[Gasket] Nitrile rubber	LBW9Z-BS7*	LBW9Z-BS7*	
	Mounting Hole Plug	Metal	[Plug] Zinc diecast [Locking Ring] Polyamide [Gasket] Nitrile rubber	LW9Z-BM	LW9Z-BM	1	Degree of protection: IP66 Tightening torque: 1.2 N·m See B-128 for dimensions.
	Mounting Hole Plug	Rubber	Nitrile rubber	LW9Z-BP1	LW9Z-BP1	1	Degree of protection: IP65 Tightening torque: 2.0 N·m See B-128 for dimensions.
Terminal Cover		1. For SPDT/DPDT contacts	PBT (White)	LB9Z-VL2	LB9Z-VL2PN10	10	See B-128 for dimensions. See B-131 for mounting.
		2. For 3PDT contacts		LB9Z-VL3	LB9Z-VL3PN10	10	
Key	 Reversible key  Non-reversible key	For key selector switches (wave key)	Metal (zinc nickel-plated)	LA9Z-SK-*	LA9Z-SK-*PN02	2	Specify a key number in place of * in the Part No. Blank: Standard key 0H (reversible) 1H to 2H: Reversible key 3H to 6H: Non-reversible key See B-128 for dimensions.
Keys		For key selector switches (disc tumbler key)	Metal (brass nickel-plated) 18×1.8×25.1 t1.8	AS6-SK-132	AS6-SK-132PN02	2	





## Dimensions for Accessories

All dimensions in mm.

## For LB Series Standard Bezel

## Rubber Boot

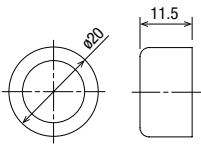
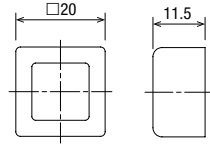
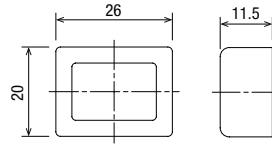
For round units  
(LB9Z-D1)For square units  
(LB9Z-D2)For rectangular units  
(LB9Z-D3)

## Mounting Hole Plug

AL-B6

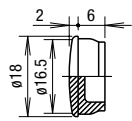

Mounting Hole Layout

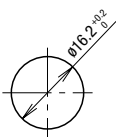

AL-BM6

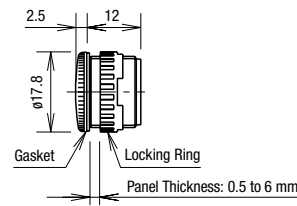

Mounting Hole Layout

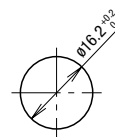

## Switch Guard (Spring Return)

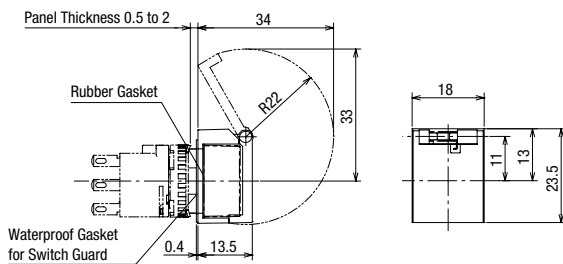
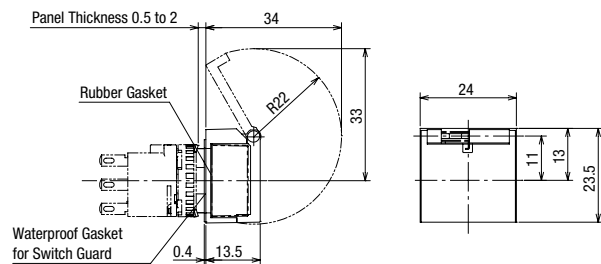
For round / square units  
(AL-K6SP)For rectangular units  
(AL-KH6SP)

## For Single Board Mounting (LA9Z-K3) (Note)

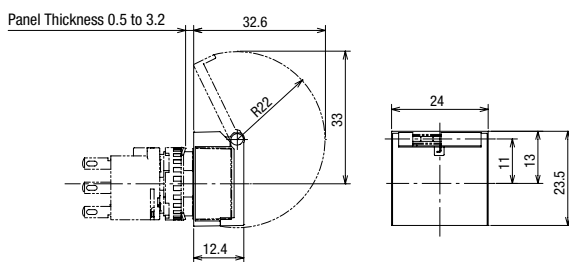

Note: The panel depth is the same for switches with or without switch guards. Both types can be installed on the same PC board.

## Switch Guard (Remains Open)

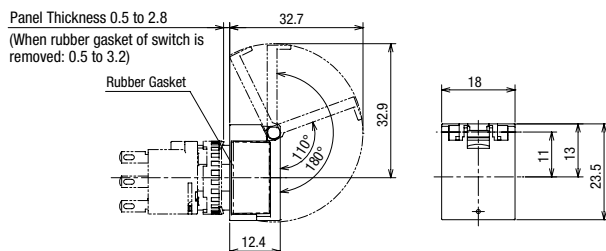
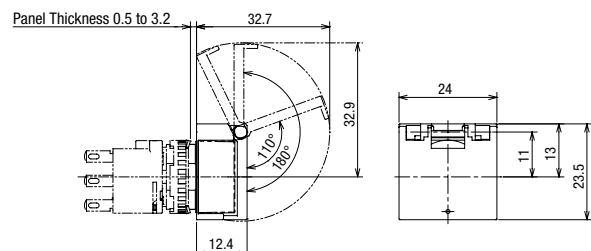
For round / square units (Note)  
(LB9Z-K2)For rectangular units (Note)  
(LB9Z-K3P)

- APEM
- Switches & Pilot Lights
- Control Boxes
- Emergency Stop Switches
- Enabling Switches
- Safety Products
- Explosion Proof
- Terminal Blocks
- Relays & Sockets
- Circuit Protectors
- Power Supplies
- LED Illumination
- Controllers
- Operator Interfaces
- Sensors
- AUTO-ID

- Flush Silhouette
- ø16
- ø22
- ø30
- Miniature
- Pilot Lights
- CW
- LW-F
- LB
- LBW
- UP
- Flush Bezel

Dimensions for Accessories

All dimensions in mm.

For LB Series Flush Bezel

Rubber Boot

For round units (LB9Z-D6)

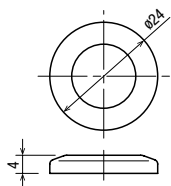

For square units (LB9Z-D7)

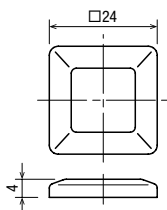

For rectangular units (LB9Z-D8)

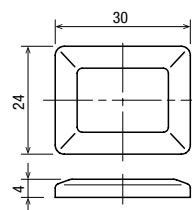

Mounting Hole Plug

For round units (LB9Z-BS6\*)

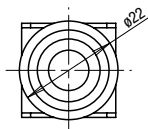

For square units (LB9Z-BS7\*)

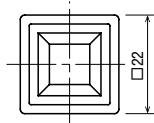

For rectangular units (LB9Z-BS8\*)

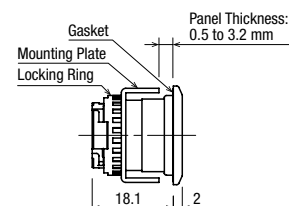
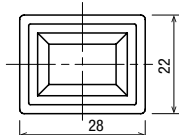

Mounting Hole Layout

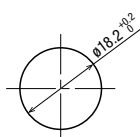

Mounting Hole Layout

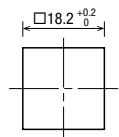

Mounting Hole Layout

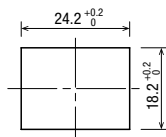

For LB Series Flush Bezel

Mounting Hole Plug

Metal (LW9Z-BM)

Mounting Hole Layout

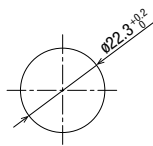
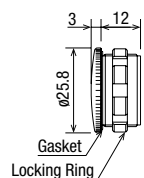

Rubber (LW9Z-BP1)

Mounting Hole Layout

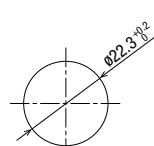
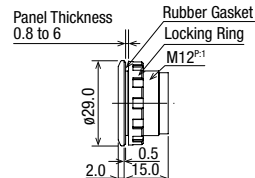

For round units (LBW9Z-BS6\*)

Mounting Hole Layout

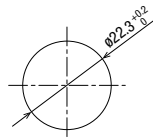
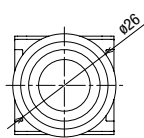

For round units (LBW9Z-BS6\*)

Mounting Hole Layout

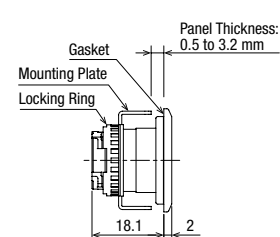
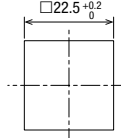
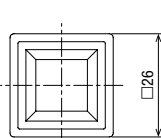

Terminal Cover

For SPDT/DPDT contacts (LB9Z-VL2)

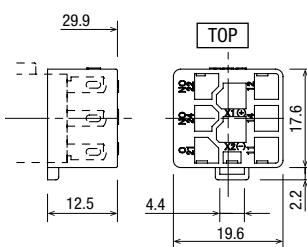

For 3PDT contacts (LB9Z-VL3)

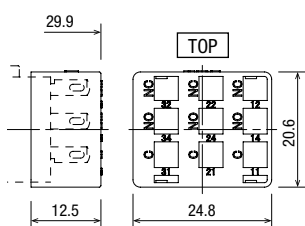

Key (Wave Key)

Reversible key

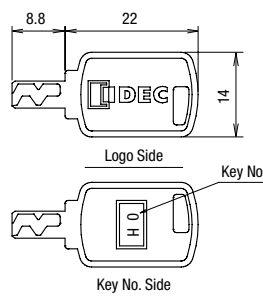

Non-reversible key

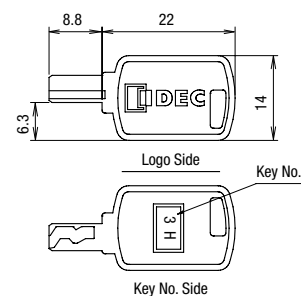

## Accessories

	Shape	Material / Dimensions (W×H×D)	Part No.	Ordering No.	Package Quantity	Remarks	
LB Series	Lens 	1. For round units	Polyarylate ø15.4 H4	AL6M-L*	AL6M-L*PN05	5	Specify the color code in place of * in the part no. A: Amber, C: Clear, G: Green, R: Red, S: Blue, Y: Yellow  Note: Use a clear lens for pure white (PW) illumination.
		2. For square units	Polyarylate □15.4 H4	AL6Q-L*	AL6Q-L*PN05	5	
		3. For rectangular units	Polyarylate W21.4 H4 D15.4	AL6H-L*	AL6H-L*PN05	5	
		4. For dome units	Polyarylate ø16 H9.4	AL6D-L*	AL6D-L*PN05	5	
	Buttons 	1. For round units	Polyarylate ø15.4 H4	AB6M-B*	AB6M-B*PN05	5	Specify the color code in place of * in the part no. B: Black, G: Green, R: Red, S: Blue W: White, Y: Yellow
		2. For square units	Polyarylate □15.4 H4	AB6Q-B*	AB6Q-B*PN05	5	
		3. For rectangular units	Polyarylate W21.4 H4 D15.4	AB6H-B*	AB6H-B*PN05	5	
	Marking plate 	1. For round units	Acrylic ø13.7 H0.8	AL6M-*	AL6M-*PN05	5	Specify the color code in place of * in the part no. B: Black, W: White  See B-133 for dimensions and engraving area.
		2. For square units	Acrylic □13.7 H0.8	AL6Q-*	AL6Q-*PN05	5	
		3. For rectangular units	Acrylic W19.7 H0.8 (0.4) D13.7	AL6H-*	AL6H-*PN05	5	
	Diffusion plate 	For dome units	Acrylic ø13.6 H2.8	AL6D-W	AL6D-WPN05	5	White
	Anti-rotation Ring 	Standard bezel	Metal (Stainless steel) □17.9 t0.6	LB9Z-LP1	LB9Z-LP1PN10	10	
Anti-rotation Ring 	Flush bezel	Metal (Stainless steel) 21×8.2×20.6 t0.8	LB9Z-LP6	LB9Z-LP6PN10	10		
LBW Series	Lens 	1. For round flush units	Polyarylate ø20 H4	HA9Z-L11*	HA9Z-L11*PN05	5	Specify the color code in place of * in the part no. A: Amber, C: Clear, G: Green, R: Red, S: Blue, Y: Yellow Note: Use a clear lens for pure white (PW) illumination.
		2. For square flush units	Polyarylate ø20 H4	HA9Z-L21*	HA9Z-L21*PN05	5	
		3. For round extended units	Polyarylate ø20.2 H7.8	LBW9Z-L12*	LBW9Z-L12*PN05	5	
	Buttons 	1. For round flush units	Polyacetal ø20 H3.2 (L5)	HA9Z-B11*	HA9Z-B11*PN05	5	Specify the color code in place of * in the part no. B: Black, G: Green, R: Red, S: Blue W: White, Y: Yellow
		2. For square flush units	Polyacetal ø20 H3.9 (L5)	HA9Z-B21*	HA9Z-B21*PN05	5	
		3. For round extended units	Polyacetal ø19.8 H7.3 (L9.1)	HA9Z-B12*	HA9Z-B12*PN05	5	
		4. For square extended units	Polyacetal ø19.8 H8 (L9.1)	HA9Z-B22*	HA9Z-B22*PN05	5	
	Marking plate 	1. For round flush units	Acrylic ø17 t0.85 (L1.1)	HA9Z-P1*	HA9Z-P1*PN05	5	Specify the color code in place of * in the part no. B: Black, W: White See B-134 for dimensions and engraving area.
		2. For square units	Acrylic □18.4 t0.85	HA9Z-P2*	HA9Z-P2*PN05	5	
	Anti-rotation Ring 	LBW series	Metal (Stainless steel) 25×8.2×24.8 t0.8	LBW9Z-LP6	LBW9Z-LP6PN10	10	
Locking ring 	All models	Polyamide ø17.9 H3.9	LB9Z-LN	LB9Z-LNPN10	10		
Illuminated selector knob operator 	Illuminated selector switches	<For operator> Polyarylate Waterproof O-gasket Nitril rubber ø15.4 H13	LA1A-F*	LA1A-F*PN02		Specify the color code in place of * in the part no. G: green, R: red, W: white	

APEM

Switches &amp; Pilot Lights

Control Boxes

Emergency Stop Switches

Enabling Switches

Safety Products

Explosion Proof

Terminal Blocks

Relays &amp; Sockets

Circuit Protectors

Power Supplies

LED Illumination

Controllers

Operator Interfaces

Sensors

AUTO-ID

Flush Silhouette

ø16

ø22

ø30

Miniature

Pilot Lights

CW

LW-F

LB

LBW

UP

Flush Bezel

## Maintenance Parts

## LB Series Maintenance LED Unit

Package Quantity: 1

Shape	Rated Operating Voltage	Part No. (Ordering No.)	* Color Code
	5V DC	LB9Z-LED5*	A: Amber G: Green PW: Pure White
	12V AC/DC	LB9Z-LED1*	R: Red S: Blue
	24V AC/DC	LB9Z-LED2*	W: White

- All LB/LBW series contain an LED unit.
- Use a pure white (PW) LED unit for yellow (Y) illumination.

## Transformer

Package Quantity: 1

Transformer	Operating Voltage	Operating Voltage Range	Part No. (Ordering No.)	Applicable Load
	100/110V AC	100/110V AC ±10%	TWR512	LB9Z-LED2* (24V AC/DC LED unit)
	200/220V AC	200/220V AC ±10%	TWR522	
	400/440V AC	400/440V AC ±10%	TWR542	

- Terminal cover (TWR-VL3) is supplied as standard.
- Connect one LB9Z-LED2\* to a transformer.

## Specifications

Part No.	TWR5□2
Operating Voltage	100/110V AC, 200/220V AC, 400/440V AC (50/60Hz)
Current Draw	2.4VA
Rated Insulation Voltage	600V
Insulation Resistance	100 MΩ minimum (500V DC megger)
Operating Temperature	-30 to +60°C (no freezing)
Storage Temperature	-40 to +80°C (no freezing)
Operating Humidity	35 to 85% RH (no condensation)
Vibration Resistance	Damage Limits: 30 Hz, amplitude 1.5 mm Operating extremes: 5 to 55 Hz, amplitude 0.5 mm
Shock Resistance	Damage limits: 1,000 m/s <sup>2</sup> Operating Extremes: 100 m/s <sup>2</sup>
Dielectric Strength	2,500V AC, 1 minute
Terminal Screw	M3.5
Applicable Wire	2 mm <sup>2</sup> maximum, 2 wires maximum
Weight (approx.)	87g

## Dimensions

All dimensions in mm.

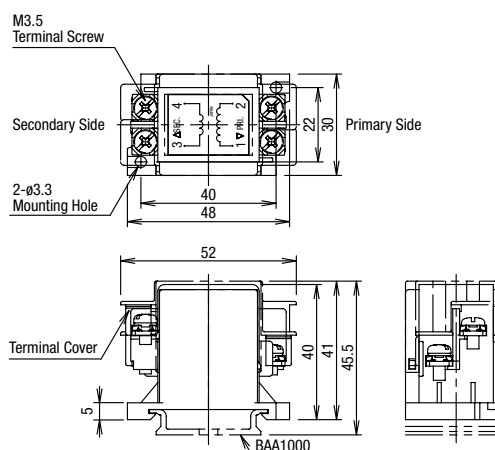

## Accessories

## 35mm DIN Rail

Part No.	Ordering No.	Length	Material	Package Quantity
BAA1000	BAA1000PN10	1,000mm	Aluminum (approx. 200g)	10
BAP1000	BAP1000PN10	1,000mm	Steel (approx. 320g)	10

## End Clip

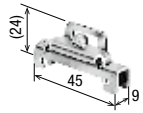
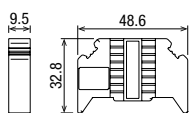
Part No.	Ordering No.	Applicable DIN Rail	Package Quantity	Dimensions
BNL6	BNL6PN10	BAA1000 BAP1000	10	 Approx. 15g Steel (Zinc-plated)
BC9Z-E/NS35N	BC9Z-E/NS35NPN10	BAA1000 BAP1000	10	 Approx. 15g

- See H-071 for DIN rail products.
- Use end clip BC9Z-E/NS35NPN10 when using 400/440V AC primary voltage transformers.

Download catalogs and CAD from <http://eu.idec.com/downloads>

## LB/LBW Series

### ⚠ Safety Precautions

- Turn off the power to the LB/LBW series before installation, removal, wiring, maintenance, and inspection. Failure to turn power off may cause electrical shocks or fire hazard.
- To avoid burning your hand, use the lamp holder tool when replacing the lamps.
- For wiring, use wires of a proper size to meet voltage and current requirements. Solder correctly according to the instructions in "Wiring" and "Notes on Terminal Cover." Improper soldering may cause overheating and create a fire hazard. Also, when using tab terminals, use receptacles of appropriate size.

APEM

Switches &amp; Pilot Lights

## Instructions

### Wiring

- 1) Solder the terminals at 350°C within 3 seconds using a 60W soldering iron. Sn-Ag-Cu type is recommended when using leadfree solder. When soldering, do not touch the LB series with the soldering iron. Also ensure that no tensile force is applied to the terminal. Do not bend the terminal or apply excessive force to the terminal.
- 2) Use non-corrosive liquid flux.

### Terminal Cover

#### Solder/tab terminal

Insert the terminal cover into the contact block with the TOP markings on the contact block and the terminal cover in the same direction.

Note: When wiring, insert the lead wires into the terminal cover holes before soldering.  
After wiring, the terminal covers cannot be installed.

#### Standard Bezel

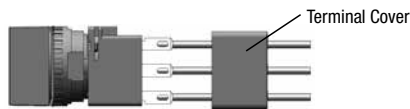

#### Flush Bezel

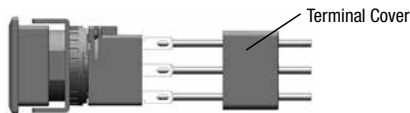

### Operating Environment

- Do not use the LB/LBW series where corrosive gases exist or under an environment exceeding the operating temperature and humidity ranges. Otherwise, damages due to contact failure or change of surface color may occur.
- Major parts of the switch are plastic. Scratches or damages may occur when scraped with a sharp object or applied with excessive load or shock. Note that this may cause operation and appearance failure of the operator and bezel.
- Adherence of detergent, cutting oil, or special chemicals to the switch may result in operation failures and appearance failures such as change of surface color.

### Handling

#### Contacts (micro switch)

When using NC (normally closed) and NO (normally open) contacts of the same microswitch, avoid connections of different voltages, or connections of different types of power supplies. Failure to observe this instruction may cause a short-circuit.

#### Protection against oil (IP65)

The LB series has been tested according to JIS C 0920: Appendix 1 by using water insoluble cutting oil Class N3, No. 8 (JIS K 2241) to prove that the switches will not be damaged by oil drops or splashes. This may not apply to special types of oils. Contact IDEC for details.

### Removing and Installing the Contact Block

- 1) Turn the locking lever on the contact block in the direction opposite to the arrow on the housing. Then the contact block can be removed.
- 2) Insert the contact block with the TOP markings on the contact block and the operator placed in the same direction. Then lock the units, turning the locking lever in the direction of the arrow.

Note: When removing/installing the contact block, or when using the contact block alone, do not apply excessive force on the actuator. Deformed actuator may affect contact operation.

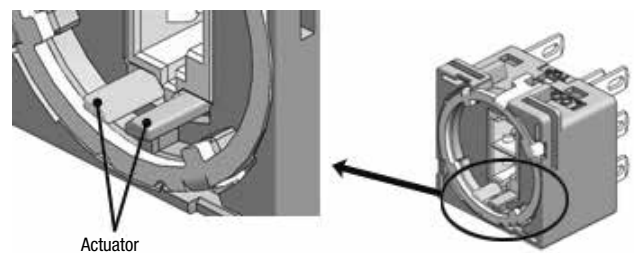
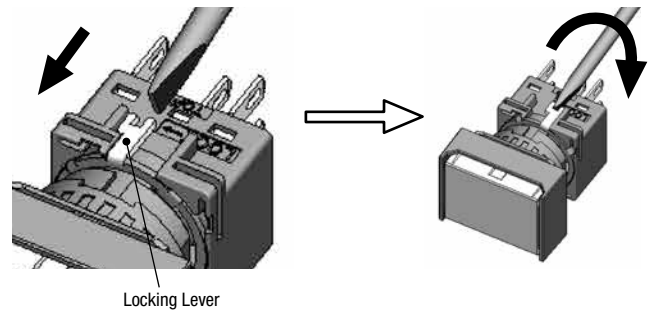

## Instructions

## Panel Mounting

Remove the contact block from the operator. Insert the operator into the panel cut-out from the front, then install the contact block to the operator.

(For Standard Bezel)

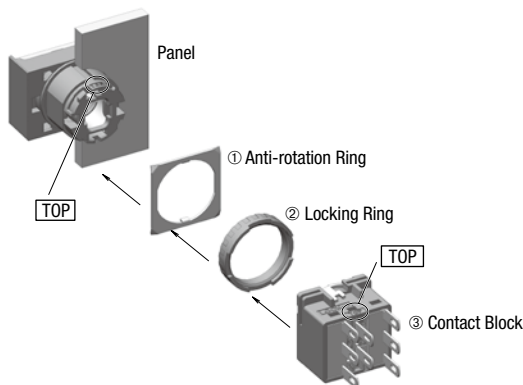

(For Flush Bezel)

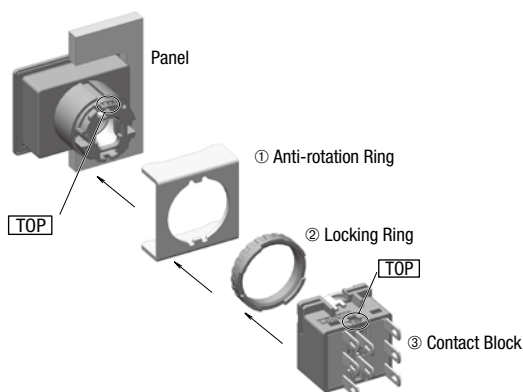

## Notes on Mounting

Use the optional ring wrench (MT-001) to mount the operator onto the panel. The recommended tightening torque is 0.5 to 0.7 N·m. Do not use pliers. Excessive tightening will damage the locking ring.

## Replacing the Lens and Marking Plate

## Removing

[Removing the operator]

Standard Bezel

- 1) From the opposite side of the TOP marking, remove the operator (lens, marking plate, and lens holder) using the optional lens removal tool (MT-101) by gripping the recesses of the color lens.

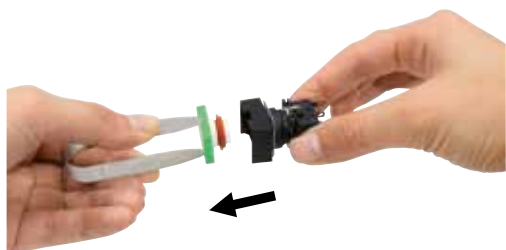

## Flush Bezel

- 1) From the opposite side of the TOP marking, push the tip (width: 3 mm, thickness: 0.5 mm) of the flat screwdriver to the groove of the color lens and pull out the operator (lens, marking plate, lens holder).

Note: For metallic bezels, the bezel may be damaged if the screwdriver is inserted from the TOP side or inserted deeply or with force into the groove of the lens.



[Removing the Operator]

- 2) Remove the marking plate by pushing the lens from the rear to disengage the latches between the lens and holder, using the screwdriver as shown below.



Note: The translucent in the lens holder cannot be removed because this filter is sealed to make the unit waterproof and oiltight.

## LBW Series Pushbutton (button style)

LBW series pushbuttons (button style, see B-097) can be removed according to the following procedure. LBW series pushbuttons (button style) cannot be removed from the front of the panel.

[Removing the Operator]

- 1) Detach the operator unit and contact block. (See Removing and Installing the Contact Block on B-131 )
- 2) Remove the button unit (button, button holder) by pushing out the cross-shaped protrusion (white) at the back of the operator with a screwdriver.

## LBW Series Illuminated Pushbutton (round extended)

Screw-in lens. The lens can be removed by turning anticlockwise.

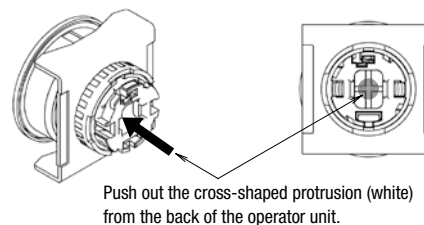

Push out the cross-shaped protrusion (white) from the back of the operator unit.

APEM

Switches &amp; Pilot Lights

Control Boxes

Emergency Stop Switches

Enabling Switches

Safety Products

Explosion Proof

Terminal Blocks

Relays &amp; Sockets

Circuit Protectors

Power Supplies

LED Illumination

Controllers

Operator Interfaces

Sensors

AUTO-ID

Flush Silhouette

ø16

ø22

ø30

Miniature

Pilot Lights

CW

LW-F

LB

LBW

UP

Flush Bezel



## Instructions

## Removing the Button

The button can be removed by inserting a small screwdriver into the groove of the button holder.

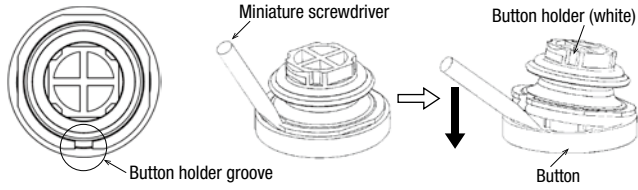

To attach the button to the button holder, align the groove on cross-shaped protrusion with the positioning protrusion on the button and insert securely.

## Installing

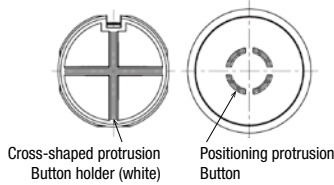

Insert the marking plate into the color lens, and press the lens onto the lens holder to engage the latches. Pay attention to the orientation of the marking plate.

## LB/LBW Series Round

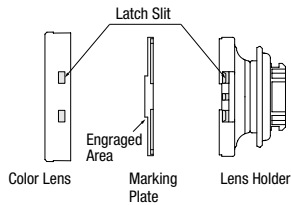

## LB Series Square/Rectangular

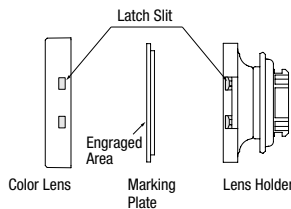

## LBW Series Square

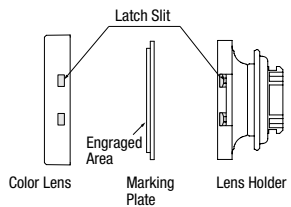

## Installing the Lens Unit and Contact Block

To insert the lens unit into the operator, press in the lens unit by making sure that the latch on the operator is aligned with the latch on the lens unit.

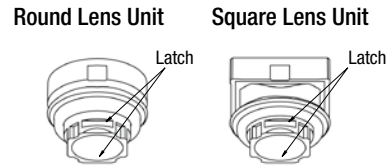

## Standard Bezel

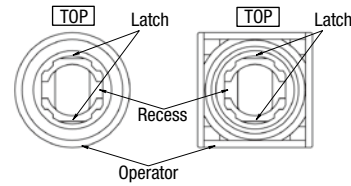

## Flush Bezel

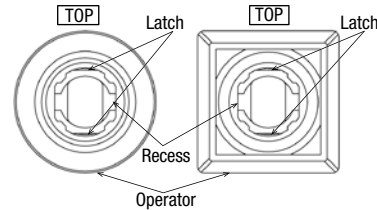

## Marking Plates and Films

For illuminated pushbuttons, pushbuttons with lens, and pilot lights, legends and symbols can be engraved on the marking plates, or printed film can be inserted under the lens for labelling purposes.

## Marking Plate and Marking Film Size

## LB Series (flush bezel / standard bezel)

Lens	Round	Square	Rectangular
Built-in Marking Plate			
Applicable Marking Film			
	<ul style="list-style-type: none"> <li>Engraving must be made on the engraving area within 0.5 mm deep.</li> <li>The marking plate is made of white acrylic resin.</li> </ul>		
	<ul style="list-style-type: none"> <li>Film thickness: 0.1 mm per film</li> <li>Marking film is not included.</li> <li>Recommended marking film: Polyester film</li> </ul>		

APEM

Switches &amp; Pilot Lights

Control Boxes

Emergency Stop Switches

Enabling Switches

Safety Products

Explosion Proof

Terminal Blocks

Relays &amp; Sockets

Circuit Protectors

Power Supplies

LED Illumination

Controllers

Operator Interfaces

Sensors

AUTO-ID

Flush Silhouette

ø16

ø22

ø30

Miniature

Pilot Lights

CW

LW-F

LB

LBW

UP

Flush Bezel

- APEM
- Switches & Pilot Lights
- Control Boxes
- Emergency Stop Switches
- Enabling Switches
- Safety Products
- Explosion Proof
- Terminal Blocks
- Relays & Sockets
- Circuit Protectors
- Power Supplies
- LED Illumination
- Controllers
- Operator Interfaces
- Sensors
- AUTO-ID

- Flush Silhouette
- ø16
- ø22
- ø30
- Miniature
- Pilot Lights
- CW
- LW-F
- LB
- LBW
- UP
- Flush Bezel

## Instructions

### LBW Series

Lens	Round Flush	Square	Round Extended
Built-in Marking Plate	<ul style="list-style-type: none"> <li>Engraving thickness: 0.5 mm max.</li> <li>The marking plate is made of white acrylic resin.</li> </ul>		
Applicable Marking Film	<ul style="list-style-type: none"> <li>Film thickness: 0.1 mm per 2 films or 0.2 mm per film.</li> <li>Marking film is not included.</li> <li>Recommended marking film: Polyester film</li> </ul>		

### LBW Series (ring-illuminated model)

Lens	Round (Note)	Square
Applicable Marking Film	<ul style="list-style-type: none"> <li>Film thickness: 0.1 mm max.</li> </ul>	

Note: Use a film with adhesive and attach on the light shield sheet. Make sure that the marking film is properly installed and does not protrude from the edge of light shield sheet.

### Ring Illuminated Model Lens Holder

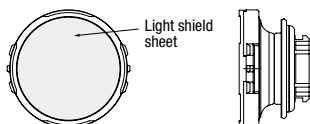

### Insertion Order of Marking Plate and Film

#### LB/LBW Series Round

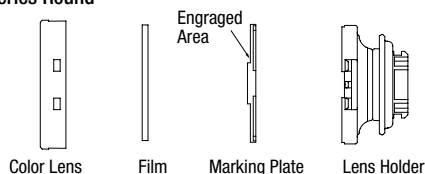

#### LB/LBW Series Square/Rectangular

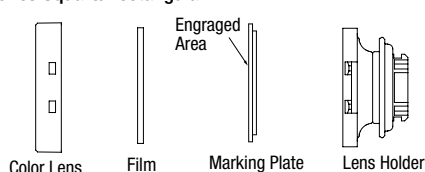

Note: Film is not included.

The marking plate must be engraved on the specified side as shown above. Pay attention to the orientation of the marking plate. When inserting a film, make sure to insert between the color lens and marking plate.

Note: Marking plate is not supplied with ring-illuminated model.

### Replacing the LED Unit

The LED unit can be replaced without tools by pulling out the lens unit from the contact block.

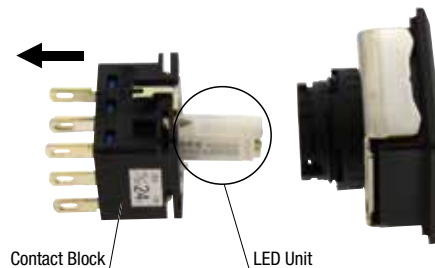

#### Orientation of the LED unit

Insert the LED unit into the contact block with the TOP markings on the contact block and LED unit in the same orientation.

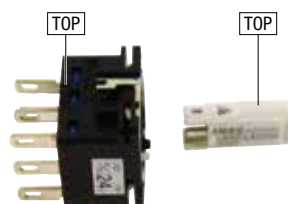

#### Notes on replacing the LED Unit

When replacing the LED unit, make sure that static electricity is not applied.

Make sure that the LB/LBW series has cooled down before replacing the LED unit. To avoid burn injuries, be careful not to touch the unit while it is still hot.

#### Notes on Using Quick Connect Terminals

- Use #110 tab quick connects, 0.5 mm-thick.
- When connecting the terminals on the left and center, make sure that surfaces of the quick connects face each other. Otherwise, short-circuit may occur.

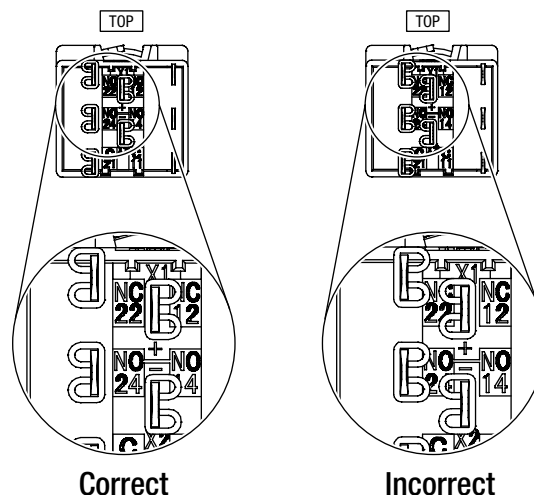

- Apply only horizontal force against the panel to the tab. The switch may be damaged if a force other than a horizontal force is applied.





## Instructions

## Installing the Rubber Boot

When using in places where the switches are subjected to water splash or an excessive amount of dust, make sure to use the optional rubber boot.

As shown in the drawing below, ① remove the gasket from the operator, and ② attach the rubber boot from the front (button side).

## Standard Bezel

For rectangular and square units, pull out the seals of the rubber boot and place them around the operator sleeve as shown below. Make sure that the seals are not twisted or tucked inside and that the gasket is removed, otherwise waterproof and dustproof characteristics are not ensured.

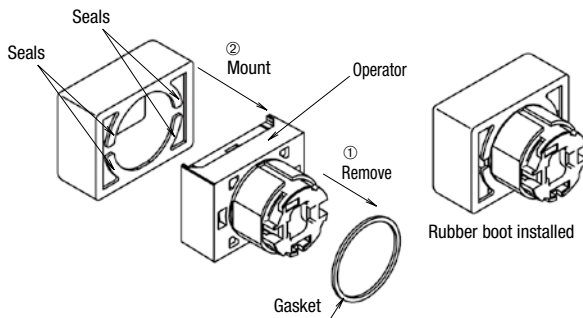
How to Install the Rubber Boot  
Rectangular

## Square

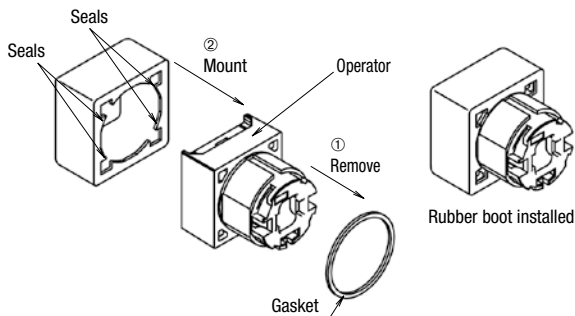

## Round

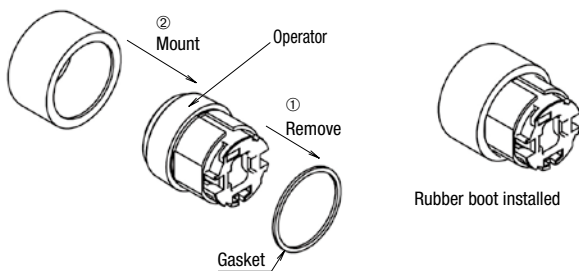

## Flush Bezel

Mount the rubber boot so that the protrusion at the bottom surface of the operator fits with the recess on the operator, placing the rubber boot all around the operator sleeve.

Make sure that the protrusion on the rubber boot and the recess on the operator is properly fitted, otherwise, the waterproof and dustproof characteristics are not ensured.

## How to Install the Rubber Boot

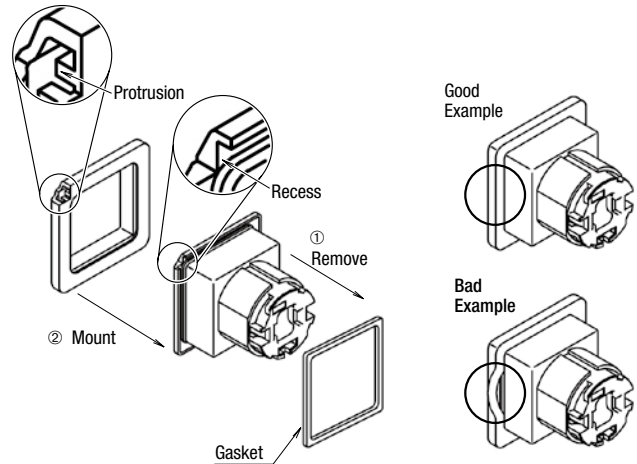

Note: Install the rubber boot before mounting the unit to the panel.

## Maintained Pushbuttons

Do not replace the buttons when the pushbutton is in the maintained position. Replacing the button in the maintained position may damage the internal mechanism. Also, do not remove the contact block with the button in the maintained position. The contact may not operate properly when the contact block is remounted. Make sure to push down fully when using the pushbuttons.

Pushbuttons and Illuminated Pushbuttons with  
Switch Guard

Do not apply force to the switch guard when the switch guard is not attached to a panel. When opening the switch guard, do not open more than 180°. The hinge may break.

## Selector Switches

When turning the operator or key, make sure that they are properly turned to each position.

## Selector Switches with Key

Observe the following instructions to prevent malfunction or damage.

- Insert the key to the bottom of the key hole.
- Do not remove the key from any key retained position.
- Besides the standard key (key number 0H), six other key numbers are available. Use a key of the matching number with the key cylinder. The standard key does not have a key number indication.
- Keys are available in two types.
  - Key numbers 0H (standard), 1H, and 2H are reversible keys which can be inserted in two ways.
  - Key numbers 3H, 4H, 5H, and 6H are non-reversible keys. Make sure of correct insertion direction.

APEM

Switches &  
Pilot Lights

Control Boxes

Emergency  
Stop SwitchesEnabling  
Switches

Safety Products

Explosion Proof

Terminal Blocks

Relays &amp; Sockets

Circuit  
Protectors

Power Supplies

LED Illumination

Controllers

Operator  
Interfaces

Sensors

AUTO-ID

Flush Silhouette

ø16

ø22

ø30

Miniature

Pilot Lights

CW

LW-F

LB

LBW

UP

Flush Bezel

APEM

Switches &amp; Pilot Lights

Control Boxes

Emergency Stop Switches

Enabling Switches

Safety Products

Explosion Proof

Terminal Blocks

Relays &amp; Sockets

Circuit Protectors

Power Supplies

LED Illumination

Controllers

Operator Interfaces

Sensors

AUTO-ID

Flush Silhouette

ø16

ø22

ø30

Miniature

Pilot Lights

CW

LW-F

LB

LBW

UP

Flush Bezel

## Instructions

### Countermeasures against Dim Lighting

Leakage currents through transistors or a contact protection circuit may cause the LED lamp to illuminate dimly even when the output is off.

When the LED lamp is illuminated by a transistor output, take the following measure.

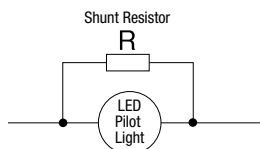

### Leakage Current Shunt Resistor Allotment Table (Recommended)

Leakage Current $I_o$	Shunt resistance R			
	Red (R), White (W)		Green (G)	
	Resistance	Rated Power	Resistance	Rated Power
0.1 mA max.	13kΩ	0.25W	18kΩ	0.25W
0.1 to 0.7 mA	2kΩ	0.25W	2.7kΩ	0.25W

### Noise

LED elements deteriorate due to extraneous noise, resulting in significant decrease in luminance, hue change, or failure of lighting. When such effects are anticipated, take a protection measure shown below. However, measures may differ according to operating environment and condition

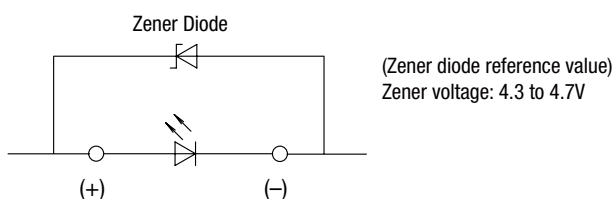

### Static Electricity (UP Series)

UP series are delicate products that may be damaged by static electricity. Make sure to take measures to prevent static electricity.

### Switch Guards

#### Opening/closing the Switch Guard

When opening/closing the switch guard while the switch guard is not installed on a panel, make sure to hold the hinge. Holding the base might result in damage. Also do not apply force on the guard in other than open/close directions, otherwise the hinge may be damaged.

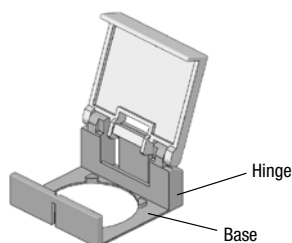

### Rubber Gasket when using LB9Z-K2 Switch Guard (remains open) for Round/Square Units

Choose to use or not to use the rubber gasket for the switch referring to the conditions described below. Note that the degree of protection is IP40 with or without the rubber gasket.

#### • When the panel thickness is up to 2.8mm

Install the switch onto the switch guard with rubber gasket, and mount on the panel.

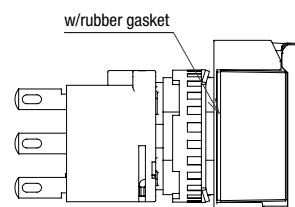

#### • When the panel thickness is 2.8 to 3.2mm

Remove the rubber gasket from the switch and install the switch onto the switch guard, and mount on the panel (discard the rubber gasket).

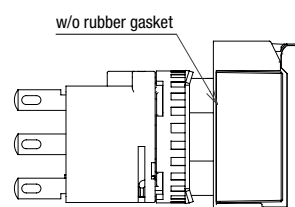

#### • Single board mounting

Remove the rubber gasket from the switch and install the switch onto the switch guard, and mount on the panel (discard the rubber gasket).

