

FARW/BN-1E

cylindrical photosensors



Micro Detectors

Italian Sensors Technology



Indicative image

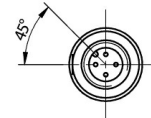
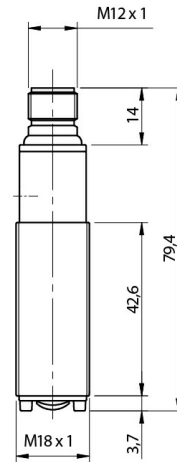

Detection properties

Nominal sensing distance	35..350mm with white target 100 x 100mm
Thermal drift of Sr	≤10% Sr
Repeat Accuracy	5%
Sensitivity adjustment	Trimmer

Application

Function Principle	Background suppression
Optic position	Axial

Outputs

Output type	NPN
Output Function	NO+NC
Switching frequency	1KHz

Electrical data

Operating Voltage	10...30Vdc
No-Load supply current	≤25mA
Load current	≤100mA
Leakage current	≤10μA

Output voltage drop	2V max. IL =100 mA
Max ripple content	10%
LED indicators	Yellow (output state)
Time delay before availability	≤200ms
Short-circuit protection	Short circuit (autoreset)
Emission	Pin point red(660 nm)
Interference to external light	5000lux (incandescent lamp), 10000lux (sunlight)

Mechanical data

Dimensions	M18 x 1 /L =79,4mm
Weight	100g
Housing Material	Nickel plated brass / PC plug
Connections	M12 plug
Active Head Material	PMMA
Tightening torque	25Nm
Operating temperature	- 25°C...+ 70° C (Without freeze)
Diameter/Dimension	M18

Test/Approvals

Approvals	CE, cULus
EMC compatibility	EN 60947-5-2
Shocks and vibrations	Vibration IEC 60068-2-6 / Shock IEC 60068-2-27
Degree of protection	IP67

Accessories

Supplied Accessories	nuts M18 x 1, screwdriver
----------------------	---------------------------

ELECTRICAL DIAGRAMS OF THE CONNECTIONS

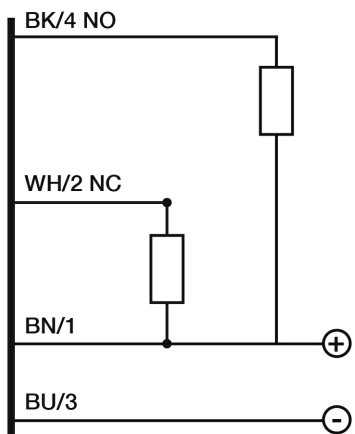

CONNECTOR

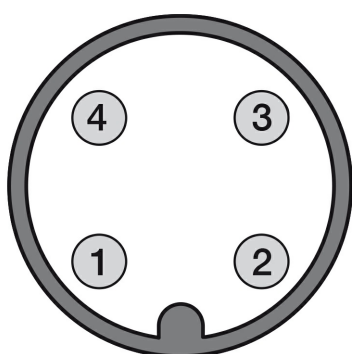

RESPONSE CURVES

Dimensione Spot

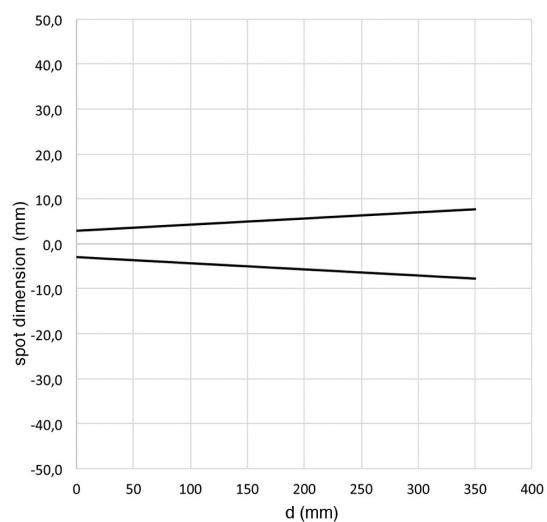

Disassamento Parallelo

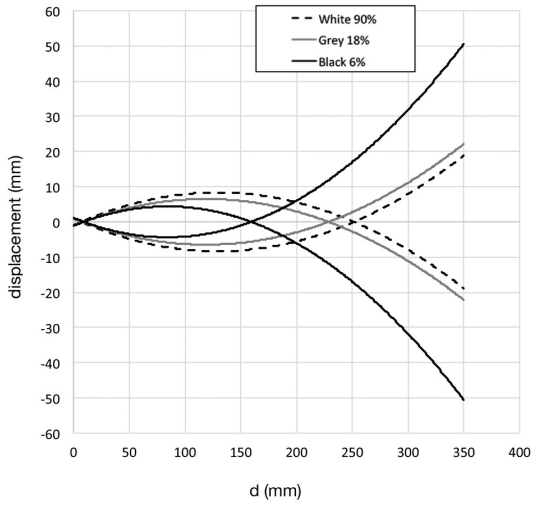

Riduzione distanza di rilevamento

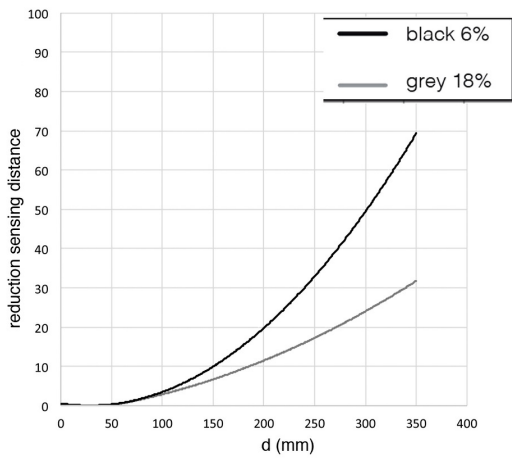

M.D. Micro Detectors S.p.A.

Strada S. Caterina, 235

41122 Modena (MO)

Tel. 059 420411

Fax 059 253973

E-mail info@microdetectors.com

date of printing

14/04/2020 16:59:19