

CF/RB6-20

optical fibers



Micro Detectors

Italian Sensors Technology



Indicative image

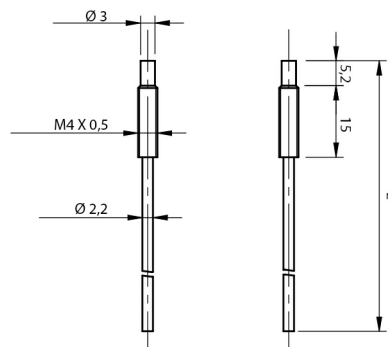

Detection properties

Distance with SSF	120 mm
Distance with FS1	120 mm
Distance with FX3	600 mm
Distance with FX4	900 mm
Distance with F1R	410 mm

Application

Function Principle Through-beam P/R

Description Plastic optical fibres

Mechanical data

Operating temperature -40°C....+70°C (posa fissa)

1 2

1 mm 1 mm

M4 con sleeve M4

vetro, ETM, inox PE, plastic

ottone nichelato nickel-plated brass

Test/Approvals

M.D.Micro Detectors S.p.A.

Strada S.Caterina, 235

41122 Modena (MO)

Tel. 059 420411

Fax 059 253973

E-mail info@microdetectors.com

date of printing

06/05/2020 14:57:34